

VANDENS SIURBLIAI, UAB
Įmonės kodas 144708571
PVM kodas LT447085716
Girulių g. 24, Šiauliai
LT78138, Lietuva



MECHANINIS SANDARIKLIS TSMG1-16 (G60) SIC/SIC/NBR/SS304 - 36.35 €

Gamintojas



APRAŠYMAS:

Mechaninis sandariklis modelis MG1 gali pakeisti „AESSEAL B02“, „BURGMANN MG1“, „FLOWSERVE 190“ ir „MTU FG1“, kuris yra plačiai naudojamas „Hecker HN 410SU“ ir kitų rūšių siurbliams.

Įprastas medžiagų derinys apima: anglis / keramika / nbr / ss304, anglies dervos / keramika / nbr / ss304 /, sic / sic / nbr / ss304, tc / tc / nbr / ss316 ir pan.

Mechaninis sandariklis modelis MG12 gali pakeisti „AESSEAL B012“, „BURGMANN MG12“, „FLOWSERVE 192“ ir „MTU FG2“, kuris yra plačiai naudojamas „Hecker HN 410KU“ ir kitų rūšių siurbliams.

Įprastas medžiagų derinys apima: anglis / keramika / nbr / ss304, anglies dervos / keramika / nbr / ss304 /, sic / sic / nbr / ss304, tc / tc / nbr / ss316 ir pan.

TS MG1 (TSG) TS MG12 (TSG2)

TS MG1(TSG) TS MG12(TSG2)

技术参数:

压力: $\leq 1.2\text{MPa}$

线速度: $\leq 10\text{m/s}$

温度: $-20^{\circ}\text{C} \sim +120^{\circ}\text{C}$

Operating Limits

Pressure: $\leq 1.2\text{MPa}$

Speed: $\leq 10\text{m/s}$

Temperature: $-20^{\circ}\text{C} \sim +120^{\circ}\text{C}$

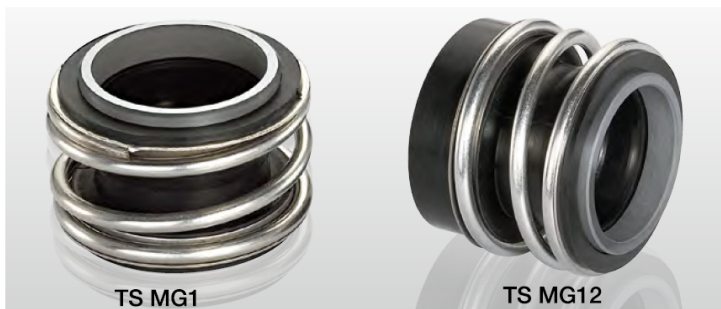

- 动环(石墨/碳化硅/碳化钨)
- 静环(陶瓷/碳化硅/碳化钨)
- 辅助密封(丁腈胶/三元乙丙胶/氟胶)
- 弹簧及其它金属件(不锈钢)

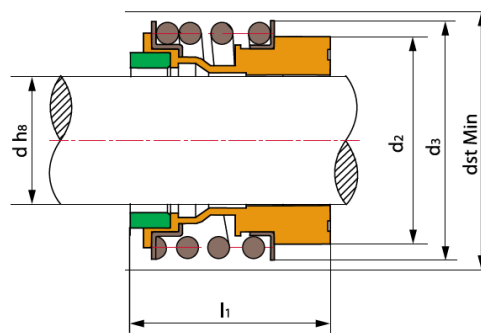

- Rotary Ring (Carbon/SiC/TC)
- Stationary Ring (Ceramic/SiC/TC)
- Secondary Seal (NBR/EPDM/VITON)
- Spring & Other Parts (SUS304/SUS316)

TS MG1					
Seal size d(mm)	d	d ₂	d ₃	d _{st}	l ₁
8	8	17.5	19.0	23	12.5
10	10	20.5	22.5	24	14.5
12	12	22.5	25.0	26	15.0
14	14	26.5	28.5	30	17.0
15	15	26.5	28.5	30	17.0
16	16	26.5	28.5	30	17.0
18	18	29.0	32.0	33	19.5
19	19	33.0	37.0	38	21.5
20	20	33.0	37.0	38	21.5
22	22	33.0	37.0	38	21.5
24	24	38.0	42.5	44	22.5
25	25	38.0	42.5	44	23.0
28	28	44.0	49.0	50	26.5
30	30	44.0	49.0	50	26.5
32	32	46.0	53.5	55	27.5
33	33	46.0	53.5	55	27.5
35	35	50.0	57.0	59	28.5
38	38	53.0	59.0	61	30.0
40	40	55.0	62.0	64	30.0
42	42	58.0	65.5	67	30.0
43	43	58.0	65.5	67	30.0
45	45	60.0	68.0	70	30.0
48	48	63.0	70.5	74	30.5
50	50	65.0	74.0	77	30.5
53	53	70.0	78.5	81	33.0
55	55	72.0	81.0	83	35.0
58	58	75.0	85.5	88	37.0
60	60	79.0	88.5	91	38.0
65	65	84.0	93.5	96	40.0
68	68	88.0	96.5	100	40.0
70	70	90.0	99.5	103	40.0
75	75	95.0	107.0	110	40.0
80	80	100.0	112.0	116	40.0
85	85	107.0	120.0	124	41.0
90	90	114.0	127.0	131	45.0
95	95	119.0	132.0	136	46.0
100	100	124.0	137.0	140	47.0

TS MG12					
Seal size d(mm)	d	d ₂	d _{st}	d ₃	l ₁
10	10	20.5	24	22.5	25.9
12	12	22.5	26	25.0	25.9
14	14	26.5	30	28.5	28.4
16	16	26.5	30	28.5	28.4
18	18	29.0	33	32.0	30.0
20	20	33.0	38	37.0	30.0
22	22	33.0	38	37.0	30.0
24	24	38.0	44	42.5	32.5
25	25	38.0	44	42.5	32.5
28	28	44.0	50	49.0	35.0
30	30	44.0	50	49.0	35.0
32	32	46.0	55	53.5	35.0
33	33	46.0	55	53.5	35.0
35	35	50.0	59	57.0	35.0
38	38	53.0	61	59.0	36.0
40	40	55.0	64	62.0	36.0
43	43	58.0	67	65.5	36.0
45	45	60.0	70	68.0	36.0
48	48	63.0	74	70.5	36.0
50	50	65.0	77	74.0	38.0
53	53	70.0	81	78.5	36.5
55	55	72.0	83	81.0	36.5
58	58	75.0	88	85.5	41.5
60	60	79.0	91	88.5	41.5
65	65	84.0	96	93.5	41.5
68	68	88.0	100	96.5	41.2
70	70	90.0	103	99.5	48.7
75	75	95.0	110	107.0	48.7
80	80	100.0	116	112.0	48.0
85	85	107.0	124	120.0	46.0
90	90	114.0	131	127.0	51.0
95	95	119.0	136	132.0	51.0
100	100	124.0	140	137.0	51.0