

VANDENS SIURBLIAI, UAB  
Įmonės kodas 144708571  
PVM kodas LT447085716  
Girulių g. 24, Šiauliai  
LT78138, Lietuva



## **MECHANINIS SANDARIKLIS TS301-17 SIC/SIC/NBR/SS304 - 33.5 €**

**Gamintojas**

---



### **APRAŠYMAS:**

---

Riebokšliai: serija TS 301

Veikimo ribos:

- Slėgis:  $\leq 0,6$  MPa
- Greitis:  $\leq 10$  m/s
- Temperatūra:  $-30$  °C □  $+ 200$  °C

Medžiagos:

- Sukamasis žiedas (plastikinė anglis / anglis / Sic / TC)
- Stacionarus žiedas (keramikinis / Sic / Tc)
- Antrinis sandariklis (nbr / Epdm / VITON)
- Spyruoklė ir kitos dalys (Sus304 / Sus316)

Matmenys:

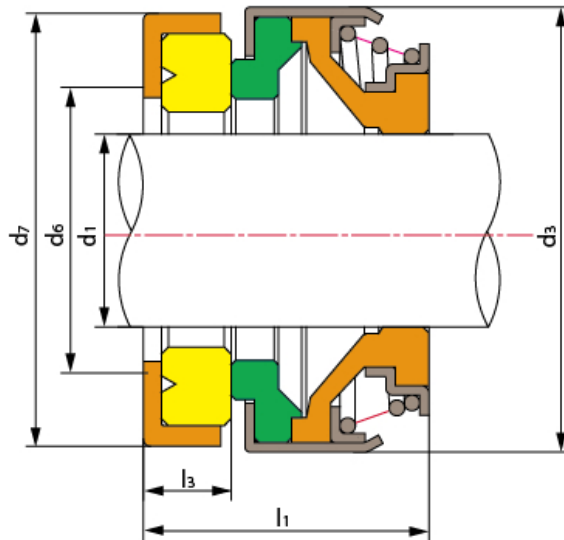

Model	$d_1$ (mm)	$d_3$	$d_6$	$d_7$	$l_1$	$l_3$
TS301-6	6	18	8	22	14	4
TS301-8S	8	18	10	22	15	4
TS301-8M	8	20	10	22/26	15/16.5	4.0/5.5
TS301-8L	8	24	10	26	16.5	5.5
TS301-10	10	24	12	26	21	8
TS301-11	11	24	13	26	21	8
TS301-12	12	24	14	25/26	21	8
TS301-13	13	24	15	26	18.5/21	5.5/8.0
TS301-13L	13	28	16	28	21	8
TS301-13H	13	32	16	29.5	30.5	8
TS301-14	14	28	16	28/28.5	21	8
TS301-14L	14	32	16	29.5	21	8
TS301-15S	15	28	16	28.5/30	21	8
TS301-15M	15	32	16	30/29.5	21	8
TS301-15L	15	39	18	38	21	8
TS301-16S	16	28	16	29.5/30	21	8
TS301-16M	16	32	18	29.5	21	8
TS301-16L	16	39	18	38	21	8
TS301-16H	16	32	16	30	29	10
TS301-17	17	39	19	42	21	8
TS301-18	18	39	20	42	21	8

Model	$d_1$ (mm)	$d_3$	$d_6$	$d_7$	$l_1$	$l_3$
TS301-19	19	39	21	42	21	8
TS301-20	20	39	22	42	21	8
TS301-20L	20	42	24	45	23	10
TS301-22S	22	36	24	45	26.5	10
TS301-22L	22	42	24	45	23	10
TS301-23	23	47	25	50	23.5	10
TS301-24	24	47	26	50	23.5	10
TS301-25	25	42	27	50	23.5	10
TS301-25L	25	47	27	50	23.5	10
TS301-26	26	47	29	50	23.5	10
TS301-27	27	47	30	50	23.5	10
TS301-28	28	54	31	57	25	10
TS301-30	30	54	33	57	25	10
TS301-32	32	54	35	57	25	10
TS301-35	35	60	38	63	26	10
TS301-38	38	65	41	68	30	12
TS301-40	40	65	43	68	30	12
TS301-45	45	70	48	73	32	12
TS301-50	50	85	52	88	38	15
TS301-55	55	85	58	88	38	15
TS301-60	60	105	63	110	45	15
TS301-65	65	105	\	110	47	15



## TS 301

### Operating Limits

Pressure:  $\leq 0.6\text{MPa}$

Speed:  $\leq 10\text{m/s}$

Temperature:  $-30^{\circ}\text{C} \sim +200^{\circ}\text{C}$

Model	d <sub>1</sub> (mm)	d <sub>3</sub>	d <sub>6</sub>	d <sub>7</sub>	l <sub>1</sub>	l <sub>3</sub>	Model	d <sub>1</sub> (mm)	d <sub>3</sub>	d <sub>6</sub>	d <sub>7</sub>	l <sub>1</sub>	l <sub>3</sub>
TS301-6	6	18	8	22.0	14.0	4.0	TS301-19	19	39	21	42.0	21.0	8.0
TS301-8S	8	18	10	22.0	15.0	4.0	TS301-20	20	39	22	42.0	21.0	8.0
TS301-8M	8	20	10	22/26	16.5	4.0/5.5	TS301-20L	20	42	24	45.0	23.0	10.0
TS301-8L	8	24	10	26.0	16.5	5.5	TS301-22S	22	36	24	45.0	26.5	10.0
TS301-10	10	24	12	26.0	21.0	8.0	TS301-22L	22	42	24	45.0	23.0	10.0
TS301-11	11	24	13	26.0	21.0	8.0	TS301-23	23	47	25	50.0	23.5	10.0
TS301-12	12	24	14	25/26	21.0	8.0	TS301-24	24	47	26	50.0	23.5	10.0
TS301-13	13	24	15	26.0	19.5	5.5/8.0	TS301-25	25	42	27	50.0	23.5	10.0
TS301-13L	13	28	16	28.0	21.0	8.0	TS301-25L	25	47	27	50.0	23.5	10.0
TS301-13H	13	32	16	29.5	30.5	8.0	TS301-26	26	47	29	50.0	23.5	10.0
TS301-14	14	28	16	28/28.5	21.0	8.0	TS301-27	27	47	30	50.0	23.5	10.0
TS301-14L	14	32	16	29.5	21.0	8.0	TS301-28	28	54	31	57.0	25.0	10.0
TS301-15S	15	28	16	28.5/30	21.0	8.0	TS301-30	30	54	33	57.0	25.0	10.0
TS301-15M	15	32	16	30/29.5	21.0	8.0	TS301-32	32	54	35	57.0	25.0	10.0
TS301-15L	15	39	18	38.0	21.0	8.0	TS301-35	35	60	38	63.0	26.0	10.0
TS301-16S	16	28	16	29.5/30	21.0	8.0	TS301-38	38	65	41	68.0	30.0	12.0
TS301-16M	16	32	18	29.5	21.0	8.0	TS301-40	40	65	43	68.0	30.0	12.0
TS301-16L	16	39	18	38.0	21.0	8.0	TS301-45	45	70	48	73.0	32.0	12.0
TS301-16H	16	32	16	30.0	29.0	10.0	TS301-50	50	85	52	88.0	38.0	15.0
TS301-17	17	39	19	42.0	21.0	8.0	TS301-55	55	85	58	88.0	38.0	15.0
TS301-18	18	39	20	42.0	21.0	8.0	TS301-60	60	105	63	110.0	45.0	15.0
							TS301-65	65	105	\	110.0	47.0	15.0
							TS301-70	70	105	\	110.0	47.0	15.0

TRISUN 冠

轻型密封件  
Single-Spring Mechanical Seal