

VANDENS SIURBLIAI, UAB  
Įmonės kodas 144708571  
PVM kodas LT447085716  
Girulių g. 24, Šiauliai  
LT78138, Lietuva

 vandens  
SIURBLIAI  
VANDUO BE RŪPESČIŲ

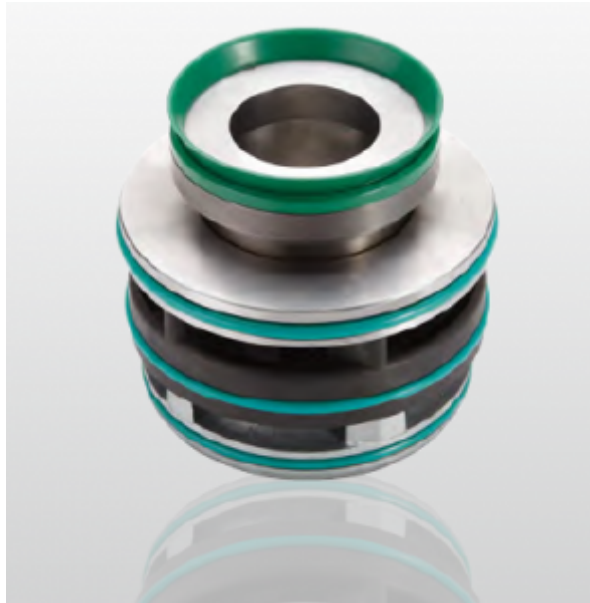

## **MECHANINIS SANDARIKLIS TSXE-20 TC/TC/VIT/SUS304 - 363 €**

**Gamintojas**

---



### **APRAŠYMAS:**

---

Mechaniniai sandarikliai: TS XE serija Medžiagos:

- Sukamasis žiedas (TC)
- Stacionarus žiedas (TC)
- Antrinis sandariklis (NBR / VITON / EPDM)
- Spyruoklė ir kitos dalys (SUS304 / SUS316)
- Kitos dalys (plastikinės)
- Stacionarus įdėklas (aliuminio lydinys)

Matmenys:

# TS XE

- Rotary Ring (TC)
- Stationary Ring (TC)
- Secondary Seal (NBR/VITON/EPDM)
- Spring & other Parts (SUS304/SUS316)
- Other Parts (Plastic)
- Stationary Seat (Aluminum alloy)

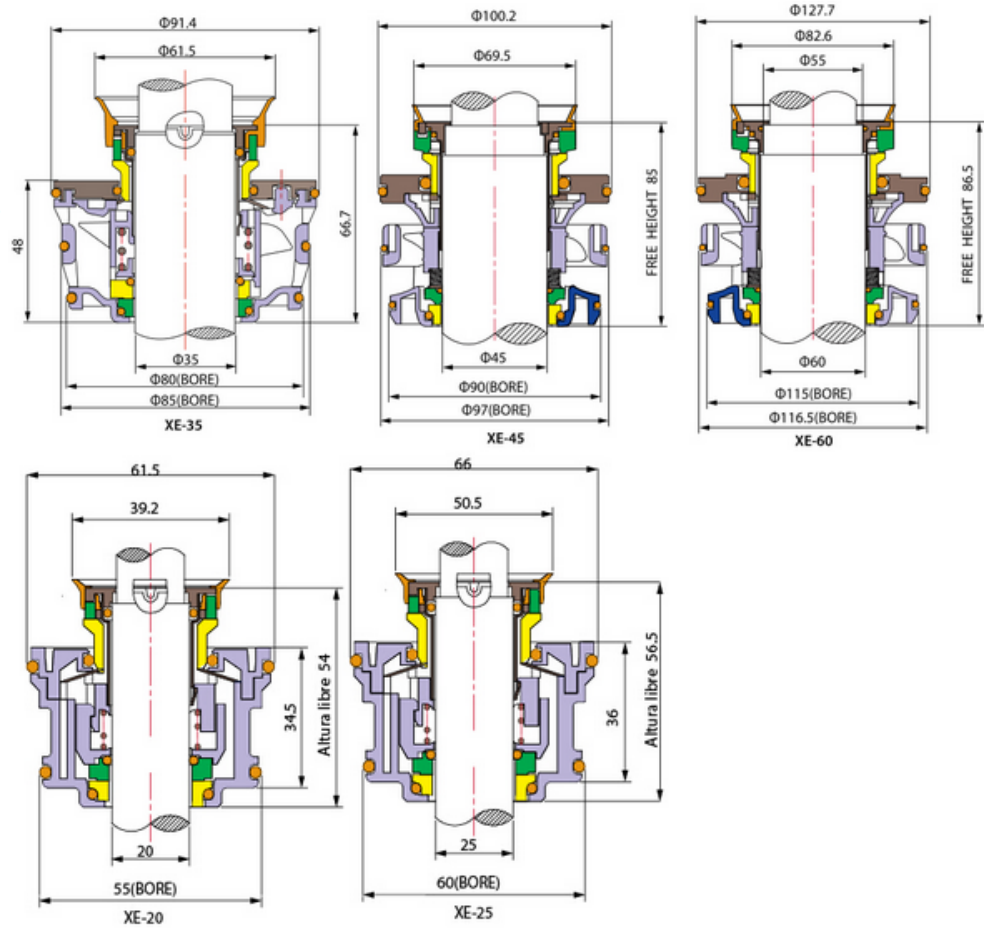

MODEL	For Flygt and Grindex Pumps & Mixers
XE-20	1520, 2610, 2620, 2630, 2640, 4610, 4620
XE-25	2660, 4630, 4640
XE-35	2670, 3153, 5100.21, 5100, 211, 5100.220, 5100.221
XE-45	3171, 4650, 4660, 5100.250, 5100.251, 5100.260, 5100.261
XE-60	3202, 4670, 4680, 5100.300, 5100.310, 5150.300, 5150.310
XE-90	5150.35, 5150.36, 5150.350, 5150.360

Gamintojas: [TRISUN](http://TRISUN)

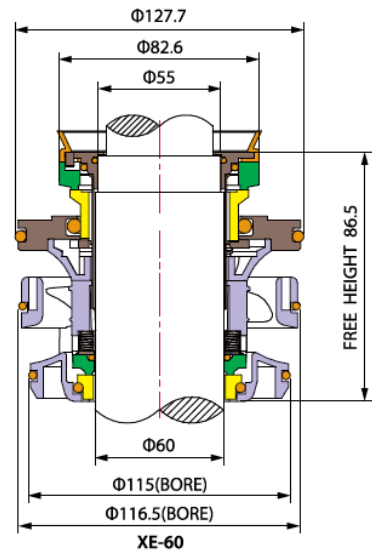
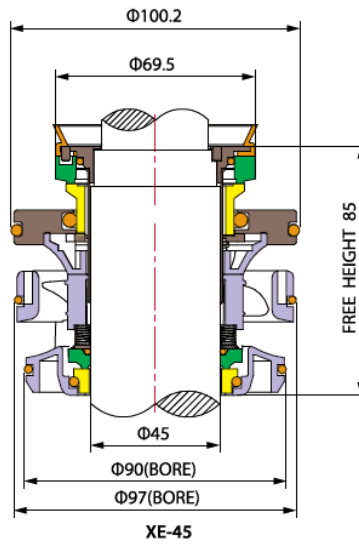
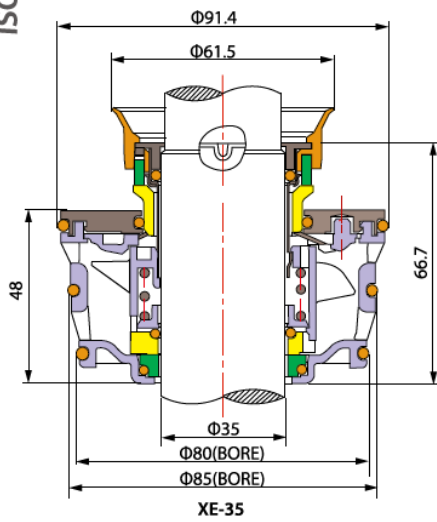
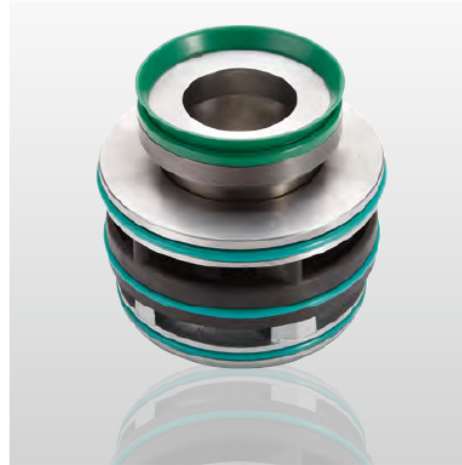
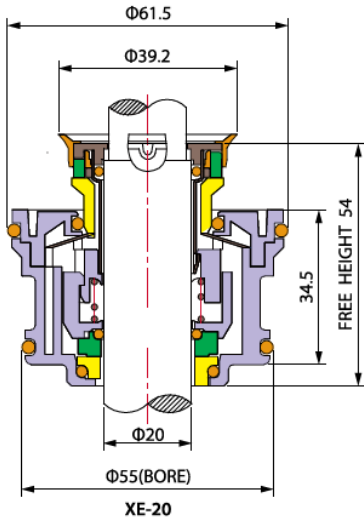

### Operating Limits

Pressure:  $\leq 1.2\text{MPa}$

Speed:  $\leq 10\text{ m/s}$

Temperature:  $-30^{\circ}\text{C} \sim +180^{\circ}\text{C}$

- Rotary Ring(TC)
- Stationary Ring(TC)
- Secondary Seal (NBR/VITON/EPDM)
- Spring & other Parts(SUS304/SUS316)
- Other Parts(Plastic)