

Receiver

From

Society
Reference
Address
Phone
Fax
E-mail

Item n° :

60185505

Model :

EVOSTA3 80/180

Pump data

Pressure rating : 1 MPa
Min. fluid temperature : -10 °C
Max. fluid temperature : 110 °C
EEI : ≤ 0,19

Minimum suction head :

Temperature °C 90
Minimum suction head : m 10

Requested data

Flow :
Head :
Fluid (%) :
Fluid Temperature : 20 °C
Density : 998,3 kg/m³
Kinematic viscosity : 1,005 mm²/s
Vapor pressure :

Hydraulic data (duty point)

Flow :
Head :

Materials

Stator jacket AISI 316
Impeller Ultrason
Shaft Alumina
Bearing housing Brass
Bushing Alumina
Rotor Fe
Axial bearing Graphite

Curve tolerance according to ISO 9906

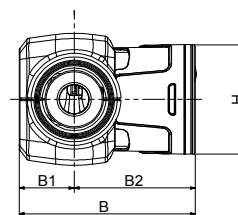
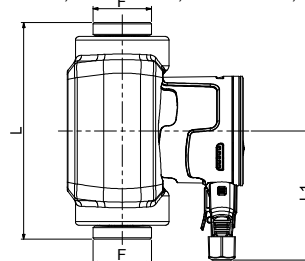
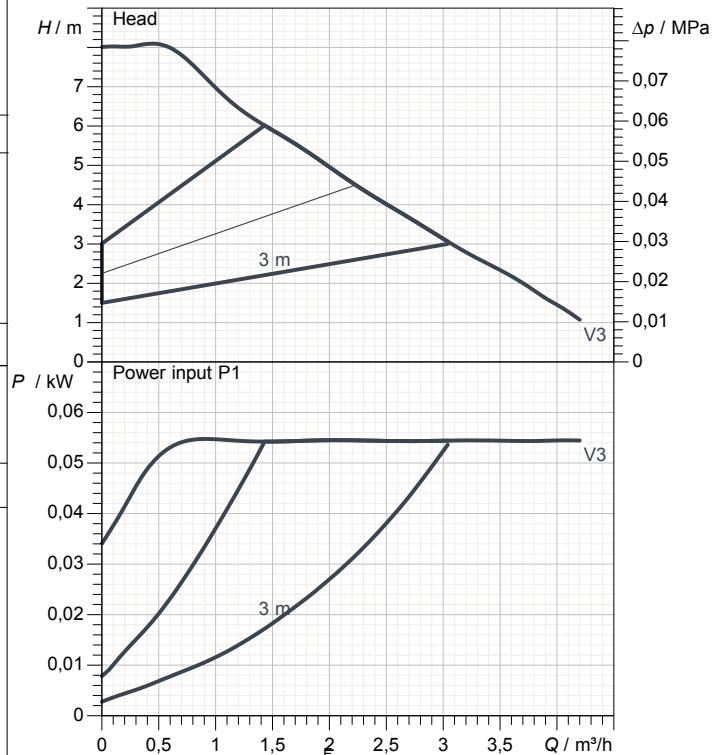

Motor data

Motor brand : DAB
Power input P1 : 0,055 kW
Rated voltage : 1~ 230 V 50 Hz
Nominal current : 0,47 A
Degree of protection : IP X5

Dimensions in mm

B	144,1	L1	107,5				
B1	45						
B2	99,1						
F	1"1/2						
H	91						
L	180						

Weight : 2,22 kg

Pump connection

Suction side : 1" 1/2 G
Discharge side : 1" 1/2 G



PERFORMANCE CURVES

2019-08-20

Page 2 / 3

DAB PUMPS S.p.A.
Via Marco Polo, 14 - 35035 Mestrino (PD), Italy
Tel. +39 049 5125000 - Fax +39 049 5125950
www.dabpumps.com

Receiver

From

Society
Reference
Address
Phone
Fax
E-mail

EVOSTA3 80/180

Curve tolerance according to ISO 9906

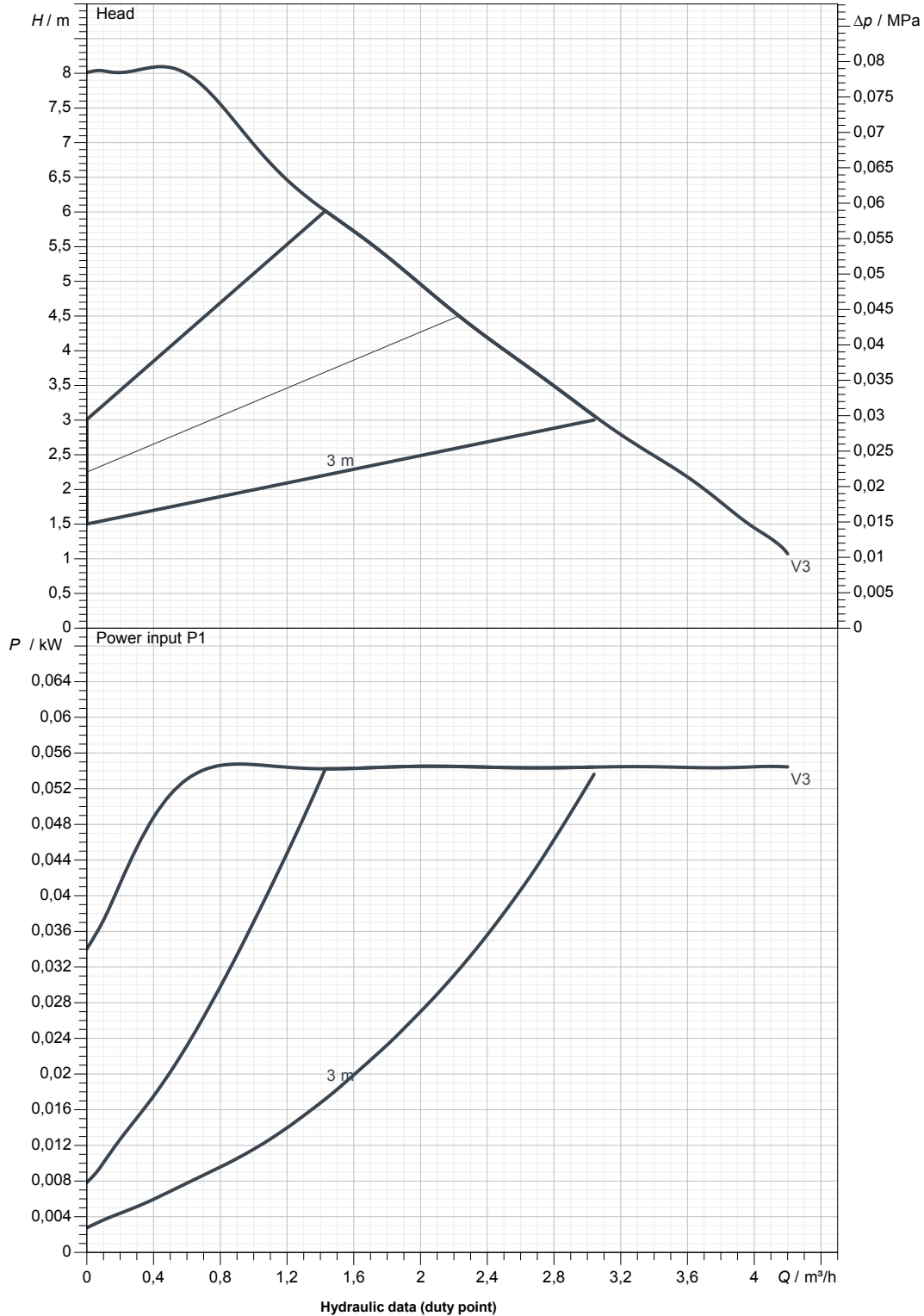

Suction side :
1" 1/2 G
10 bar (1000 KPa)

Discharge side :
1" 1/2 G
10 bar (1000 KPa)

Flow :

Head :

Rated speed :
2900 1/min

MAIN_PROJECT_TITLE

BUSINESS_PROCESS_ID

OWNER

ISSUE_DATE



DIMENSIONAL DRAWING

2019-08-20

Page 3 / 3

DAB PUMPS S.p.A.
Via Marco Polo, 14 - 35035 Mestrino (PD), Italy
Tel. +39 049 5125000 - Fax +39 049 5125950
www.dabpumps.com

Receiver

From

Society
Reference
Address
Phone
Fax
E-mail

EVOSTA3 80/180

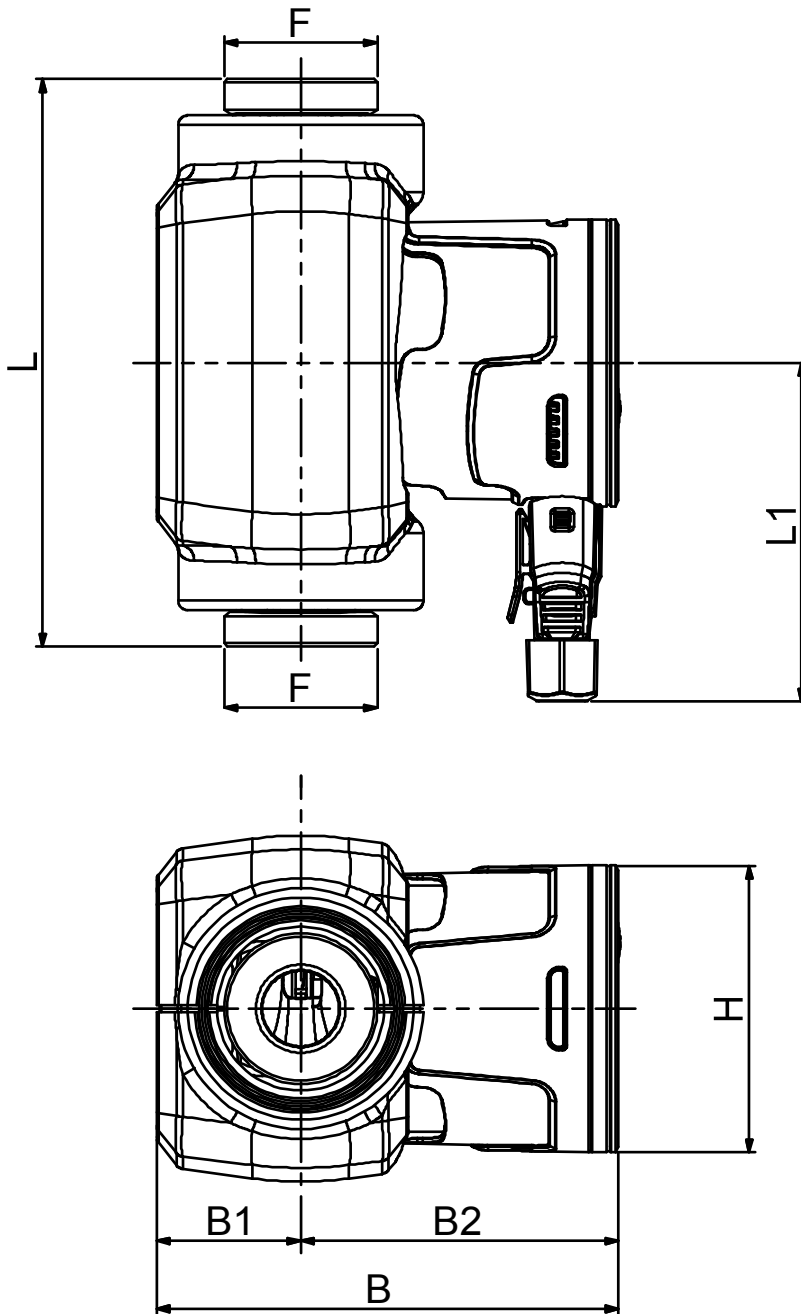

Dimensions in mm

1	B	144,1
2	B1	45
3	B2	99,1
4	F	1"1/2
5	H	91
6	L	180
7	L1	107,5

Pump connection

Suction
1" 1/2 G
10 bar (1000 KPa)

Discharge
1" 1/2 G
10 bar (1000 KPa)

MAIN_PROJECT_TITLE

BUSINESS_PROCESS_ID

OWNER

ISSUE_DATE