

OPTIDRIVE™

AC Variable Speed Drive

General Purpose Drive
Easy control for all motor types

Easy to Use



0.37kW – 22kW / 0.5HP – 30HP
110–480V Single & 3 Phase Input

IP20

IP66

Easy to Use

General Purpose Drive

Simply power on and **Optidrive E3** is up and running, providing precise motor control and energy savings using the factory settings.



Simple Commissioning

14 parameter basic setup. Default settings suitable for most applications. Contactor style connection for simple wiring.



Intuitive Keypad Control

Precise digital control at the touch of a button.



Application Macros

Switch between **Industrial, Pump & Fan** modes to optimise Optidrive E3 for your application.

Industrial | Pump | Fan

See [Page 6](#)

IP20

Up to 22kW

- ✓ Easy to use
- ✓ Compact & robust

See [Page 4](#)



Take a closer look at the stunning Optidrive E3



www.invertekdrives.com/optidrive-e3

Sensorless Vector Control for all Motor Types

IM

IE2 & IE3
Induction
Motors

PM

AC Permanent
Magnet
Motors

BLDC

Brushless DC
Motors

SynRM

Synchronous
Reluctance
Motors

Precise and reliable control for
IE2, IE3 & IE4 motors

IP66

Up to 7.5kW

- ✓ Dust-tight
- ✓ Washdown ready

See **Page 5**



Key Features

- ✓ Internal Category C1 EMC filter
- ✓ Internal PI control
- ✓ Internal brake chopper
- ✓ Dual analogue inputs
- ✓ Operates up to 50°C
- ✓ Bluetooth® connectivity
- ✓ Option for control of single phase motors (see **Page 8**)

Modbus RTU

CANopen

on-board as standard

Internal Category C1 EMC Filter

An internal filter in every Optidrive E3 saves cost and time for installation.

Cat C1 according to EN61800-3:2004



OPTIDRIVE™

IP20

Up to 22kW

Compact, robust and reliable general purpose drive for panel mounting

Simple Installation

DIN rail and keyhole mounting options

Fast Connection

5mm rising clamp terminals with captive screws

Quick Reference

Integrated help card

Operates up to 50°C

Modbus RTU

CANopen

on-board as standard

Incredibly Easy to Use

- ✓ Built in PI control, EMC filter (C1) & brake chopper
- ✓ Application macros for industrial, fan and pump operation
- ✓  Bluetooth® connectivity

OPTISTICK

Rapid parameter cloning and Bluetooth PC interface

See **Page 10**

Dual analogue inputs

Motor supply connects at base

Controls Multiple Motor Types

- ✓ IE2, 3 & 4
- ✓ IM, PM, BLDC and SynRM

Simply Power Up

Optidrive E3 provides precise motor control and energy savings using the factory settings. Simply power up and the drive can immediately deliver energy savings.

14 basic parameters allow simple adjustment for your application if required, with up to 50 parameters available in total for a highly flexible performance.

4 sizes cover global supply ratings



OPTIDRIVE™ E³

IP66

Up to 7.5kW

Enclosed drives for direct machine mounting, dust-tight and ready for washdown duty

Coated Heatsink as Standard

Ideal for hygiene based operations requiring washdown — such as food and beverage

Fanless Heatsink

For reliable, cost effective operation

Switched or Non-Switched

Conformal coating as standard



Dust-Tight Design

Install directly on your processing equipment and be sure of protection from dust and contaminants.

Washdown Ready

With a sealed ABS enclosure and corrosion resistant heatsink, the Optidrive E3 IP66 is ideal for high-pressure washdown applications.

Optidrive E3 IP66 Switched

Simply wire up the drive, turn the inbuilt potentiometer and the motor will start running – allowing immediate energy savings

Saving energy cannot be easier than this!

For ultimate ease of use

- Local Speed Potentiometer
- Run Reverse / Off / Run Forward Switch
- Lockable Mains Disconnect / Isolator



Application Macros

Switch modes at the touch of a button to optimise Optidrive E3 for your application

Single parameter application macro selection



Industrial Mode

Industrial Mode optimises Optidrive E3 for load characteristics of typical industrial applications.

Applications include:

- ✓ Conveyors
- ✓ Mixers
- ✓ Treadmills

Sensorless Vector provides high starting torque and excellent speed regulation

IP20 panel mount units or **IP66** for direct machine mounting



Rapid parameter cloning using **OPTISTICK**

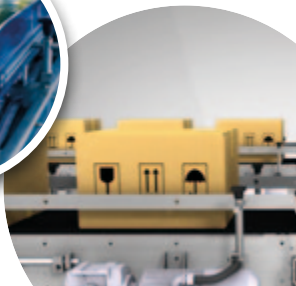

Pump Mode

Pump Mode makes energy efficient pump control easier than ever.

Applications include:

- ✓ Dosing Pumps
- ✓ Borehole Pumps
- ✓ Transfer Pumps
- ✓ Swimming Pools
- ✓ Spas
- ✓ Fountains

- Constant or variable torque
- Internal PI control



Fan Mode

Fan Mode (inc. fire operation) makes air handling a breeze, ideal for simple HVAC systems.

Applications include:

- ✓ Air Handling Units
- ✓ Ventilation Fans
- ✓ Circulating Fans
- ✓ Air Curtains
- ✓ Kitchen Extract



- High efficiency **variable torque** motor control
- Flying start capability
- Mains loss ride through
- PI control

Instant Power Savings

The graph below shows the incredible efficiency of Optidrive E3 for controlling airflow compared to traditional damper control methods.

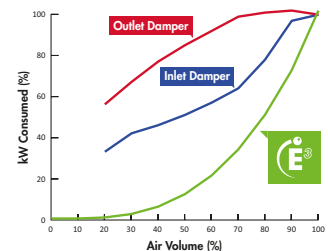

Modbus RTU
CANopen

on-board as standard

How much energy could you save?

Estimate potential energy savings, CO₂ emissions and financial savings for your application with the Inverter Drives Energy Savings Calculator app.



www.inverterdrives.com/calculator

	kW	HP	Amps	Size	Model Code	Product Family	Generation	Frame Size	Voltage Code	Capacity	Supply Phases	EMC Filter	Brake Transistor	Enclosure Type
110–115V ± 10% 1 Phase Input	0.37	0.5	2.3	1	ODE - 3 - 1 1 0023 - 1	0	1	#						
	0.75	1	4.3	1	ODE - 3 - 1 1 0043 - 1	0	1	#						
	1.1	1.5	5.8	2	ODE - 3 - 2 1 0058 - 1	0	4	#						
200–240V ± 10% 1 Phase Input	0.37	0.5	2.3	1	ODE - 3 - 1 2 0023 - 1	#	1	#						
	0.75	1	4.3	1	ODE - 3 - 1 2 0043 - 1	#	1	#						
	1.5	2	7	1	ODE - 3 - 1 2 0070 - 1	#	1	#						
	1.5	2	7	2	ODE - 3 - 2 2 0070 - 1	#	4	#						
	2.2	3	10.5	2	ODE - 3 - 2 2 0105 - 1	#	4	#						
200–240V ± 10% 3 Phase Input	0.37	0.5	2.3	1	ODE - 3 - 1 2 0023 - 3	0	1	#						
	0.75	1	4.3	1	ODE - 3 - 1 2 0043 - 3	0	1	#						
	1.5	2	7	1	ODE - 3 - 1 2 0070 - 3	0	1	#						
	1.5	2	7	2	ODE - 3 - 2 2 0070 - 3	#	4	#						
	2.2	3	10.5	2	ODE - 3 - 2 2 0105 - 3	#	4	#						
380–480V ± 10% 3 Phase Input	0.75	1	2.2	1	ODE - 3 - 1 4 0022 - 3	#	1	#						
	1.5	2	4.1	1	ODE - 3 - 1 4 0041 - 3	#	1	#						
	1.5	2	4.1	2	ODE - 3 - 2 4 0041 - 3	#	4	#						
	2.2	3	5.8	2	ODE - 3 - 2 4 0058 - 3	#	4	#						
	4	5	9.5	2	ODE - 3 - 2 4 0095 - 3	#	4	#						

Replace # in model code with colour-coded option

Enclosure & Display Types

X IP66 Non-switched

Y IP66 Switched

2 IP20

2 IP20

EMC Filter

F Internal EMC Filter

0 No Internal EMC Filter

IP20

Size	1	2	3	4
mm Height	173	221	261	420
mm Width	83	110	131	171
mm Depth	123	150	175	212
kg Weight	1.0	1.7	3.2	9.1
Fixings	4xM5	4xM5	4xM5	4xM8

IP66

Size	1	2	3
mm Height	232	257	310
mm Width	161	188	210.5
mm Depth	179	187	252
kg Weight	3.1	4.1	7.6
Fixings	4xM4	4xM4	4xM4

Drive Specification

Input Ratings	Supply Voltage	110 – 115V ± 10% 200 – 240V ± 10% 380 – 480V ± 10%	Control Specification	Control Method	Sensorless Vector Speed Control PM Vector Control BLDC Control Synchronous Reluctance	Application Features	PI Control	Internal PI Controller Standby / Sleep Function	
	Supply Frequency	48 – 62Hz		PWM Frequency	4–32kHz Effective		Fire Mode	Bidirectional Selectable Speed Setpoint (Fixed / PI / Analog / Fieldbus)	
	Displacement Power Factor	> 0.98		Stopping Mode	Ramp to stop: User Adjustable 0.1–600 secs Coast to stop		Maintenance & Diagnostics	Fault Memory	Last 4 Trips stored with time stamp
	Phase Imbalance	3% Maximum allowed		Braking	Motor Flux Braking Built-in braking transistor (not frame size 1)		Data Logging	Logging of data prior to trip for diagnostic purposes: Output Current Drive Temperature DC Bus Voltage	
	Inrush Current	< rated current		Skip Frequency	Single point, user adjustable		Monitoring	Hours Run Meter	
	Power Cycles	120 per hour maximum, evenly spaced		Setpoint Control	Analog Signal 0 to 10 Volts 10 to 0 Volts 0 to 20mA 20 to 0mA 4 to 20mA 20 to 4mA		Standards Compliance	Low Voltage Directive	Adjustable speed electrical power drive systems. EMC requirements
Output Ratings	Output Power	110V 1 Ph Input: 0.5–1.5HP (230V 3 Ph Output) 230V 1 Ph Input: 0.37–4kW (0.5–5HP) 230V 3 Ph Input: 0.37–11kW (0.5–15HP) 400V 3 Ph Input: 0.75–22kW 460V 3 Ph Input: 1–30HP	Fieldbus	Built-in	CANopen 125–1000 kbps Modbus RTU 9.6–115.2 kbps selectable	I/O Specification	EMC Directive	2004/108/EC Cat C1 according to EN61800-3:2004	
	Overload Capacity	150% for 60 Seconds 175% for 2.5 seconds		Power Supply	24 Volt DC, 100mA, Short Circuit Protected 10 Volt DC, 5mA for Potentiometer		Machinery Directive	2006/42/EC	
	Output Frequency	0 – 500Hz, 0.1Hz resolution		Programmable Inputs	4 Total 2 Digital 2 Analog / Digital selectable		Conformance	CE, UL, C-Tick	
Ambient Conditions	Temperature	Storage: –40 to 60°C Operating: –10 to 50°C	I/O Specification	Digital Inputs	8 – 30 Volt DC, internal or external supply Response time < 4ms	Programming	Keypad	Built-in keypad as standard Optional remote mountable keypad	
	Altitude	Up to 1000m ASL without derating Up to 2000m maximum UL approved Up to 4000m maximum (non UL)		Analog Inputs	Resolution: 12 bits Response time: < 4ms Accuracy: ± 2% full scale Parameter adjustable scaling and offset		Display	7 Segment LED	
	Humidity	95% Max, non condensing		Programmable Outputs	2 Total 1 Analog / Digital 1 Relay		PC	OptiTools Studio	
Enclosure	Ingress Protection	IP20, IP66	I/O Specification	Relay Outputs	Maximum Voltage: 250 VAC, 30 VDC Switching Current Capacity: 6A AC, 5A DC	I/O Specification	Analog Outputs	0 to 10 Volt	

OPTIDRIVE™

For Single Phase Motors



IP20

IP66

Up to 1.1kW

Single Phase Motor Control for PSC & Shaded-Pole Motors

Key Features

- ✓ 110–115V and 200–240V models
- ✓ Small mechanical envelope
- ✓ Rugged industrial operation
- ✓ Fast setup, and simple operation with 14 basic parameters
- ✓ Unique motor control strategy optimised for single phase motors
- ✓ Motor current and rpm indication
- ✓ Built in PI control, EMC filter (C1) & brake chopper
- ✓ Application macros for industrial, fan and pump operation
- ✓ Bluetooth® connectivity

Modbus RTU

CANopen

on-board as standard

150% overload for 60 secs
(175% for 2 secs)



Pump control in swimming pools & spas



Simple airflow control

Dedicated to Single Phase Motor Control

Designed to be cost effective and easy to use, the Optidrive E3 for Single Phase Motors is for use with PSC (Permanent Split Capacitor) or Shaded-Pole Single Phase induction motors.

Optidrive E3 for Single Phase Motors uses a revolutionary motor control strategy to achieve reliable intelligent starting of single phase motors.

- Removes the need for 3 phase supply wiring
- Provides the same performance features as the 3 phase Optidrive E3
- The ideal energy saving solution where high starting torque is not required — typically including fans, blowers, centrifugal pumps, fume extractors and air flow controllers

Special Boost Phase

To ensure reliable starting of single phase motors, the drive initially ramps the motor voltage up to rated voltage whilst maintaining a fixed starting frequency, before reducing the frequency and voltage to the desired operating point.

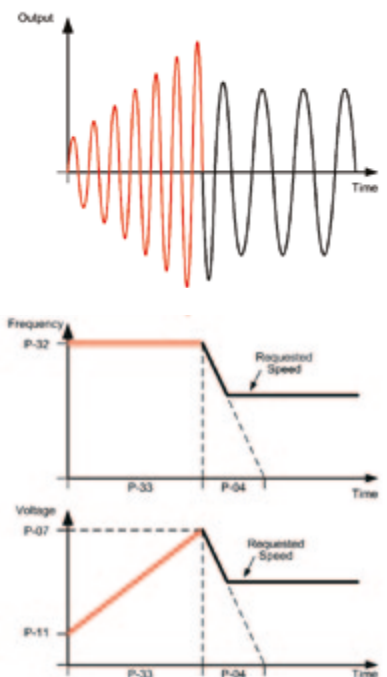

OPTIDRIVE™ E³

For Single Phase Motors

	kW	HP	Amps	Size	Model Code	Product Family	Generation	Frame Size	Voltage Code	Capacity	Supply Phases	EMC Filter	Brake Transistor	Enclosure Type	Single Phase Output
110–115V ± 10% 1 Phase Input	0.37	0.5	7	1	ODE - 3 - 1 1 0070 - 1	# 1	# -	-	01						
	0.55	0.75	10.5	2	ODE - 3 - 2 1 0105 - 1	# 4	# -	-	01						
200–240V ± 10% 1 Phase Input	0.37	0.5	4.3	1	ODE - 3 - 1 2 0043 - 1	# 1	# -	-	01						
	0.75	1	7	1	ODE - 3 - 1 2 0070 - 1	# 1	# -	-	01						
	1.1	1.5	10.5	2	ODE - 3 - 2 2 0105 - 1	# 4	# -	-	01						

Replace # in model code with colour-coded option

Enclosure & Display Types



IP20

Size	1	2
mm Height	173	221
mm Width	83	110
mm Depth	123	150
kg Weight	1.0	1.7
Fixings	4 x M5	4 x M5

IP66

Size	1	2
mm Height	232	257
mm Width	161	188
mm Depth	179	187
kg Weight	3.1	4.1
Fixings	4 x M4	4 x M4

EMC Filter

F	Internal EMC Filter
0	No Internal EMC Filter

Model Code Guide:

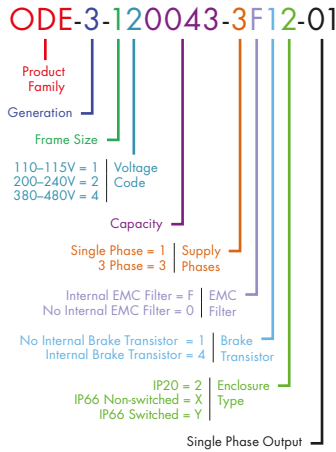

Drive Specification

Input Ratings	Supply Voltage	110 – 115V ± 10% 200 – 240V ± 10%	Control Specification	Control Method	V/F Voltage Vector Energy Optimised V/F	Application Features	PI Control	Internal PI Controller Standby / Sleep Function	
	Supply Frequency	48 – 62Hz		PWM Frequency	4–32kHz Effective		Fire Mode	Selectable Speed Setpoint (Fixed / PI / Analog / Fieldbus)	
	Displacement Power Factor	> 0.98		Stopping Mode	Ramp to stop: User Adjustable 0.1–600 secs Coast to stop		Maintenance & Diagnostics	Fault Memory	Last 4 Trips stored with time stamp
	Phase Imbalance	3% Maximum allowed		Braking	Motor Flux Braking Built-in braking transistor (frame size 2)			Data Logging	Logging of data prior to trip for diagnostic purposes: Output Current Drive Temperature DC Bus Voltage
	Inrush Current	< rated current		Skip Frequency	Single point, user adjustable			Monitoring	Hours Run Meter
	Power Cycles	120 per hour maximum, evenly spaced		Setpoint Control	Analog Signal		0 to 10 Volts 10 to 0 Volts 0 to 20mA 20 to 0mA 4 to 20mA 20 to 4mA	Standards Compliance	Low Voltage Directive
Output Ratings	Output Power	110V 1 Ph Input: 0.5–0.75HP 230V 1 Ph Input: 0.37–1.1kW (0.5–1.5HP)	Digital		Motorised Potentiometer (Keypad) Modbus RTU CANopen	EMC Directive	2004/108/EC 230V 1Ph, Filtered Units : Cat C1 according to EN61800-3:2004		
Overload Capacity	150% for 60 Seconds 175% for 2.5 seconds	Fieldbus	Built-in	CANopen	125–1000 kbps	Machinery Directive	2006/42/EC		
Output Frequency	0 – 120Hz, 0.1Hz resolution			Modbus RTU	9.6–115.2 kbps selectable	Conformance	CE, UL, C-Tick		
Typical Efficiency	> 98%	I/O Specification	Power Supply	24 Volt DC, 100mA, Short Circuit Protected 10 Volt DC, 5mA for Potentiometer	Programmable Inputs	4 Total 2 Digital 2 Analog / Digital selectable			
Ambient Conditions	Temperature		Storage: –40 to 60°C Operating: –10 to 50°C	Digital Inputs		8 – 30 Volt DC, internal or external supply Response time < 4ms	Analog Inputs	Resolution: 12 bits Response time: < 4ms Accuracy: ± 2% full scale Parameter adjustable scaling and offset	
Altitude	Up to 1000m ASL without derating Up to 2000m maximum UL approved Up to 4000m maximum (non UL)		Programming	Keypad		Built-in keypad as standard Optional remote mountable keypad		Programmable Outputs	2 Total 1 Analog / Digital 1 Relay
	Humidity			95% Max, non condensing		Display	7 Segment LED		Relay Outputs
Vibration	Conforms to EN61800-5-1		PC	OptiTools Studio		Analog Outputs	0 to 10 Volt		

Options & Accessories

OPTISTICK



Bluetooth®

Optistick **OPT-2-STICK-IN**
Rapid Commissioning Tool

- Allows copying, backup and restore of drive parameters
- Provides Bluetooth wireless interface to a PC running OptiTools Studio

Remote Keypads



Optipad **OPT-2-OPPAD-IN**
Remote Keypad & OLED Display

Optiport 2 **OPT-2-OPPAD-IN**
Remote Keypad & LED Display

RJ45 Accessories



Cable Splitter **OPT-J45SP-IN**
RS485 3 Way Data Cable Splitter RJ45

External EMC Filters, Input Chokes & Output Filters are available

See www.invertekdrives.com for details

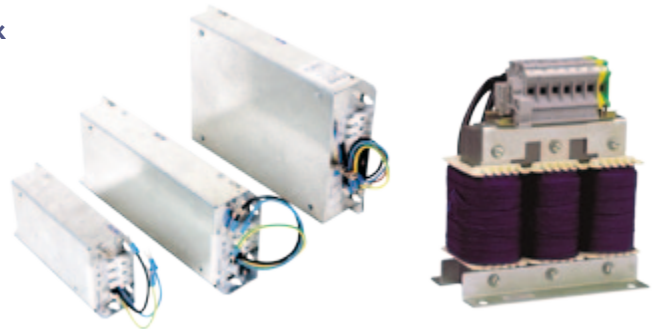

OptiTools Studio

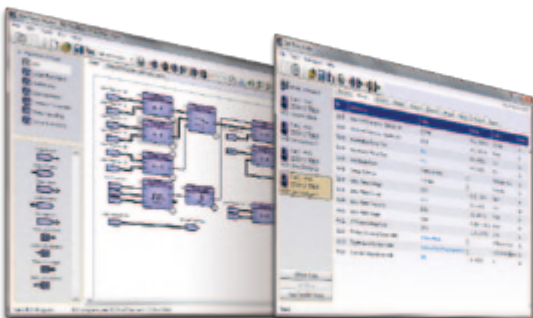

Drive commissioning and parameter backup

- Real-time parameter editing
- Drive network communication
- Parameter upload, download and storage
- Simple PLC function programming
- Real-time scope function and data logging
- Real-time data monitoring

Compatible with:
Windows XP, Windows Vista & Windows 7

Proven Worldwide in Low Power Applications



Cooling loop for solar energy research
Solar Tech Lab, Italy

Chain wax development for Team Sky cycling team
Muc-Off, UK

Business-critical climate control for commercial horticulturist
Hatziminas Flowers, Greece

Chilled water pump control predicted to save AED 12385 per year
Al Jahili Fort, UAE

Efficient water circulation gives energy savings of 60% per annum
Leisure World, Australia

Pallet handling in **UK**

Olive oil decanting in **Greece**

Seed processing in **Netherlands**

Pizza making in **Belgium**

Chamfering machines in **Italy**

Machine tool OEM in **UK**

Chemical fume removal in **Singapore**

Sawmill optimisation in **UK**

Precision polishing in **Switzerland**

See www.inverterdrives.com/solutions for full case studies



Optidrive E3

✓ Low Power Applications

Dedicated to low power applications, Optidrive E3 combines innovative technology, reliability, robustness and ease of use in a range of compact IP20 & IP66 enclosures.

✓ Simple Commissioning

14 parameter basic setup. Default settings suitable for most applications. Contactor style connection for simple wiring.

✓ Optidrive E3 IP66

Environmentally protected, IP66 rated models can be mounted directly on your processing equipment.



✓ Washdown Ready

With a sealed ABS enclosure and corrosion resistant heatsink, Optidrive E3 IP66 models are ideal for high-pressure washdown applications.

✓ On-drive Control

IP66 models feature optional, convenient controls for speed control, REV/OFF/FWD and Power ON/OFF, complete with safety lock.

✓ Single Phase Motor Control

Optidrive E3 for Single Phase Motors provides accurate speed control of single phase PSC or shaded pole motors. Special boost phase ensures reliable starting, initially ramping the motor voltage up to rated voltage whilst maintaining a fixed starting frequency, before reducing the frequency and voltage to the desired operating point.



About Invertek Drives

- ✓ Sales, service & application support in over 80 countries
- ✓ World-class production, innovation & training facilities at UK headquarters
- ✓ Global assembly cells controlled by cloud-based manufacturing database
- ✓ ISO 14001 environmental & ISO 9001 quality management systems



www.invertekdrives.com/optidrive-e3

INVERTEK DRIVES LIMITED UK Headquarters

Offa's Dyke Business Park
Welshpool, Powys, UK
SY21 8JF

Tel: +44 (0)1938 556868
Fax: +44 (0)1938 556869
Email: sales@invertekdrives.com

