

Monobloc horizontal centrifugal pumps, constructed in compliance with EN 733 standards; widely used in water supplies, pressurisation and fire-fighting systems, cooling, heating, irrigation, industrial and agricultural applications; standard supply with counter-flange.

Construction features

Pump body	cast iron
Motor bracket	cast iron
Impeller	cast iron, bronze or stainless steel
Seal type	mechanical
Pump shaft end	stainless steel AISI 304
Liquid temperature	-10 ÷ +90 °C
Operating pressure	max 10 bar

Motor

2 poles induction motor	3~ 230/400V - 50Hz P ≤ 4kW
	3~ 400/690V - 50Hz P > 4kW
	1~ 230V-50Hz
Insulation class	F
Protection degree	IPX5

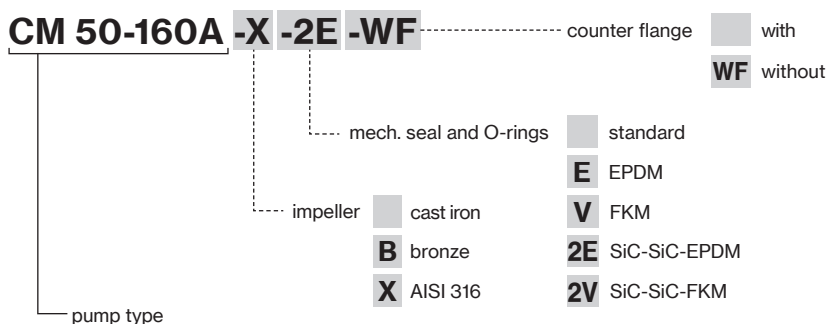

CM-CMG-CA-4CA

Centrifugal Flanged
EN 733

CM: Front suction close-coupled centrifugal pumps with close impeller mounted on IE3 motor shaft extension. Pump casing with axial suction and radial delivery on top, main dimensions and performance according to EN 733.

CMG-CMGX: Front suction centrifugal pumps connected to IE3 standard motor (stub-shaft construction). Pump casing with axial suction and radial delivery on top, main dimensions and performance according to EN 733.

CA-CAX-4CA-4CAX: Single-stage end-suction centrifugal frame-mounted pumps. Dimensions in accordance with EN 733.

TYPE	2 POLES						4 POLES				
	CM	CMG	CMGX	CA	CAT CAX CATX	Flow rate m ³ /h	Head m	4CA 4CAT	4CAX 4CATX	Flow rate m ³ /h	Head m
32-160C	■	-	-	■	■	6 ÷ 21	22,8 ÷ 14	■	■	1,5 ÷ 12	5,9 ÷ 2,6
32-160B	■	-	-	■	■	6 ÷ 24	27,7 ÷ 17	■	■	1,5 ÷ 12	7,2 ÷ 3,6
32-160A	■	-	-	■	■	6 ÷ 27	36,2 ÷ 22,1	■	■	1,5 ÷ 15	8,8 ÷ 4
32-200C	■	-	-	■	■	6 ÷ 27	40,3 ÷ 28,7	■	■	3 ÷ 18	10,8 ÷ 4,2
32-200B1	■	-	-	-	-	6 ÷ 27	48 ÷ 37,9	-	-	-	-
32-200B	■	-	-	■	■	6 ÷ 30	48 ÷ 35,4	■	■	3 ÷ 18	12,7 ÷ 6,3
32-200A1	■	-	-	-	-	6 ÷ 30	58,3 ÷ 46,6	-	-	-	-
32-200A	■	-	-	■	■	6 ÷ 33	58,3 ÷ 44,3	■	■	3 ÷ 21	15,7 ÷ 6,8
32-250C	■	-	-	■	■	6 ÷ 27	72 ÷ 61,3	■	■	3 ÷ 21	17,2 ÷ 6,5
32-250B	■	-	-	■	■	7,5 ÷ 27	84 ÷ 73,2	■	■	3 ÷ 21	20 ÷ 8,3
32-250A1	■	-	-	-	-	7,5 ÷ 27	93,6 ÷ 85,3	-	-	-	-
32-250A	■	-	-	■	■	7,5 ÷ 27	93,6 ÷ 85,5	■	■	3 ÷ 21	22,2 ÷ 9,1
40-125C	■	-	-	■	■	9 ÷ 36	18,5 ÷ 9,4	■	■	4,5 ÷ 21	4,4 ÷ 2
40-125B	■	-	-	■	■	9 ÷ 39	23,4 ÷ 13,2	■	■	4,5 ÷ 21	5,5 ÷ 3,3
40-125A	■	-	-	■	■	9 ÷ 42	27,6 ÷ 16,8	■	■	4,5 ÷ 24	6,3 ÷ 3,4
40-160B	■	-	-	■	■	9 ÷ 36	29,2 ÷ 20,5	■	■	4,5 ÷ 24	7,5 ÷ 2,5
40-160A	■	-	-	■	■	9 ÷ 42	34,9 ÷ 23,4	■	■	4,5 ÷ 24	8,9 ÷ 4,5
40-160AP	■	-	-	■	■	9 ÷ 48	39,8 ÷ 25,3	■	■	4,5 ÷ 24	11,1 ÷ 6,8
40-200B1	■	-	-	-	-	9 ÷ 39	45,5 ÷ 32,3	-	-	-	-
40-200B	■	-	-	■	■	9 ÷ 42	45,5 ÷ 29,4	■	■	6 ÷ 24	11,4 ÷ 4,7
40-200A1	■	-	-	-	-	9 ÷ 39	56,5 ÷ 44,4	-	-	-	-
40-200A	■	-	-	■	■	9 ÷ 42	56,5 ÷ 41,6	■	■	6 ÷ 24	13,9 ÷ 8,3
40-200AP	■	-	-	■	■	9 ÷ 45	61,4 ÷ 42,2	■	■	6 ÷ 24	14,9 ÷ 9,4
40-250C	■	-	-	■	■	9 ÷ 36	64,4 ÷ 55,4	■	■	9 ÷ 27	15,2 ÷ 6,6
40-250B	■	-	-	■	■	9 ÷ 39	79,9 ÷ 62,1	■	■	9 ÷ 30	18,2 ÷ 8,3
40-250A1	■	-	-	-	-	9 ÷ 42	84,6 ÷ 72,8	-	-	-	-
40-250A	■	-	-	■	■	9 ÷ 45	84,6 ÷ 69	■	■	9 ÷ 33	20,8 ÷ 8,4
40-250BM	■	-	-	■	■	9 ÷ 54	93,2 ÷ 72	-	-	-	-
40-250AM	■	-	-	■	■	9 ÷ 60	103 ÷ 77,5	-	-	-	-
50-125B	■	-	-	■	■	12 ÷ 72	20,6 ÷ 9,2	■	■	9 ÷ 42	5,5 ÷ 2,1
50-125A	■	-	-	■	■	12 ÷ 72	24,3 ÷ 14,2	■	■	9 ÷ 45	6,4 ÷ 2,9
50-160B1	■	-	-	-	-	21 ÷ 66	33,5 ÷ 21,5	-	-	-	-
50-160B	■	-	-	■	■	21 ÷ 72	33,5 ÷ 18,9	■	■	9 ÷ 42	8 ÷ 2,3
50-160A1	■	-	-	-	-	21 ÷ 72	39,8 ÷ 27,6	-	-	-	-
50-160A	■	-	-	■	■	21 ÷ 78	39,8 ÷ 25,4	■	■	9 ÷ 48	9,4 ÷ 3,1
50-200C	■	-	-	■	■	24 ÷ 72	49,7 ÷ 28,9	■	■	9 ÷ 39	12 ÷ 3,2
50-200B	■	-	-	■	■	24 ÷ 72	54,6 ÷ 35	■	■	10,5 ÷ 42	13,1 ÷ 4,2
50-200A1	■	-	-	-	-	24 ÷ 78	61,8 ÷ 39,8	-	-	-	-



TYPE	2 POLES							4 POLES			
	CM	CMG	CMGX	CA	CAT CAX CATX	Flow rate	Head	4CA 4CAT	4CAX 4CATX	Flow rate	Head
						m³/h	m			m³/h	m
50-200A	■	-	-	■	■	24 ÷ 78	61,8 ÷ 39,8	■	■	10,5 ÷ 45	14,7 ÷ 4,6
50-250C1	■	-	-	-	-	27 ÷ 60	68,2 ÷ 56,2	-	-	-	-
50-250C	■	-	-	■	■	27 ÷ 66	68,2 ÷ 52,1	■	■	12 ÷ 45	17,7 ÷ 7,5
50-250B	■	-	-	■	■	27 ÷ 72	78,4 ÷ 58,5	■	■	12 ÷ 48	20 ÷ 8,2
50-250A	■	-	-	■	■	27 ÷ 78	88,3 ÷ 61,8	■	■	12 ÷ 54	22,9 ÷ 8,4
50-315DN	-	-	-	■	-	42 ÷ 132	90,4 ÷ 73,4	-	-	-	-
50-315C	-	-	-	-	-	-	-	■	■	18 ÷ 84	24,7 ÷ 16,8
50-315CN	-	-	-	■	-	42 ÷ 132	105 ÷ 88,7	-	-	-	-
50-315B	-	-	-	-	-	-	-	■	■	18 - 90	31,4 - 21,6
50-315BN	-	-	-	■	-	42 ÷ 144	124,3 ÷ 103,5	-	-	-	-
50-315A	-	-	-	-	-	-	-	■	■	18 - 96	37,2 - 25,1
50-315AN	-	-	-	■	-	42 ÷ 144	146,9 ÷ 125,8	-	-	-	-
65-125B1	■	-	-	-	-	30 ÷ 108	20,6 ÷ 15	-	-	-	-
65-125B	■	-	-	■	■	30 ÷ 120	20,6 ÷ 13,1	■	■	18 ÷ 60	5,1 ÷ 2,8
65-125A1	■	-	-	-	-	30 ÷ 120	25,2 ÷ 18,8	-	-	-	-
65-125A	■	-	-	■	■	30 ÷ 132	25,2 ÷ 16,8	■	■	18 ÷ 72	6,3 ÷ 3
65-160C	■	-	-	■	■	42 ÷ 144	30,6 ÷ 13,9	■	■	24 ÷ 78	7,6 ÷ 2,9
65-160B	■	-	-	■	■	42 ÷ 144	35,1 ÷ 20,4	■	■	24 ÷ 78	8,6 ÷ 3,6
65-160A1	■	-	-	-	-	42 ÷ 138	42,5 ÷ 31,7	-	-	-	-
65-160A	■	-	-	■	■	42 ÷ 144	42,5 ÷ 30,9	■	■	24 ÷ 84	9,9 ÷ 4,6
65-200C1	■	-	-	-	-	54 ÷ 132	46,1 ÷ 28,9	-	-	-	-
65-200C	■	-	-	■	■	54 ÷ 138	46,1 ÷ 26,8	■	■	27 ÷ 84	11,6 ÷ 5
65-200B	■	-	-	■	■	54 ÷ 144	53,9 ÷ 34,6	■	■	27 ÷ 84	13,1 ÷ 7
65-200A	■	-	-	■	■	54 ÷ 144	61,8 ÷ 44,4	■	■	27 ÷ 84	14,8 ÷ 9,3
65-250B	■	-	-	■	■	54 ÷ 144	80,6 ÷ 47,3	■	■	27 ÷ 84	21 ÷ 8,7
65-250A	■	-	-	■	■	54 ÷ 150	91,6 ÷ 57,9	■	■	30 ÷ 90	22,9 ÷ 8,8
65-315CM	-	-	-	-	-	-	-	■	■	27 ÷ 126	23,5 ÷ 13,9
65-315CN	-	-	-	■	-	54 ÷ 180	96,5 ÷ 80,8	-	-	-	-
65-315BM	-	-	-	-	-	-	-	■	■	27 ÷ 132	28,9 ÷ 17,2
65-315BN	-	-	-	■	-	54 ÷ 195	117,9 ÷ 96,3	-	-	-	-
65-315AM	-	-	-	-	-	-	-	■	■	27 ÷ 138	34 ÷ 18,2
65-315AN	-	-	-	■	-	54 ÷ 210	138,8 ÷ 110,4	-	-	-	-
80-160E	■	-	-	■	■	66 ÷ 168	22,9 ÷ 13,7	■	■	24 ÷ 96	5,7 ÷ 2,2
80-160D	■	-	-	■	■	66 ÷ 180	27,3 ÷ 16,4	■	■	27 ÷ 102	6,8 ÷ 2,6
80-160C1	■	-	-	-	-	66 ÷ 195	30,9 ÷ 18,4	-	-	-	-
80-160C	■	-	-	■	■	66 ÷ 195	30,9 ÷ 18,4	■	■	30 ÷ 108	7,4 ÷ 3,1
80-160B	■	-	-	■	■	66 ÷ 210	35,9 ÷ 22	■	■	33 ÷ 120	8,9 ÷ 3,5
80-160A	■	-	-	■	■	66 ÷ 225	40,5 ÷ 23,9	■	■	36 ÷ 132	9,8 ÷ 3,8
80-200B	■	-	-	■	■	72 ÷ 225	54,5 ÷ 38,5	■	■	42 ÷ 132	13,1 ÷ 7,1
80-200A	■	-	-	■	■	72 ÷ 240	61,7 ÷ 43,9	■	■	42 ÷ 144	14,7 ÷ 7,5
80-250B	-	■	■	■	■	96 ÷ 225	80 ÷ 58,8	■	■	42 ÷ 132	19,2 ÷ 11,1
80-250A	-	■	■	■	■	96 ÷ 240	92,8 ÷ 65,2	■	■	42 ÷ 144	22,9 ÷ 12,6
80-315B	-	-	-	-	-	-	-	■	■	42 ÷ 150	28,3 ÷ 19,9
80-315BN	-	-	-	■	-	78 ÷ 255	112,4 ÷ 90,8	-	-	-	-
80-315A	-	-	-	-	-	-	-	■	■	42 ÷ 168	35 ÷ 23,7
80-315AN	-	-	-	■	-	78 ÷ 255	141,4 ÷ 118,5	-	-	-	-
100-160B	■	-	-	-	-	96 ÷ 330	40,7 ÷ 25,7	-	-	-	-
100-160A	■	-	-	-	-	96 ÷ 330	45,1 ÷ 31,9	-	-	-	-
100-200D	-	-	-	■	■	108 ÷ 300	43,1 ÷ 26,6	■	■	48 ÷ 168	10,8 ÷ 4,8
100-200C	-	-	-	■	■	108 ÷ 330	48,4 ÷ 28,1	■	■	48 ÷ 168	12 ÷ 6,3
100-200B	-	■	■	■	■	108 ÷ 330	56,8 ÷ 39,7	■	■	48 ÷ 180	13,6 ÷ 7,8
100-200A	-	■	■	■	■	108 ÷ 360	62,2 ÷ 42,5	■	■	48 ÷ 192	15,4 ÷ 9,1
100-250E	-	-	-	-	-	-	-	■	■	60 ÷ 180	16,9 ÷ 11,4
100-250D	-	-	-	-	-	-	-	■	■	60 ÷ 192	19,6 ÷ 12,7



TYPE	2 POLES							4 POLES			
	CM	CMG	CMGX	CA	CAT CAX CATX	Flow rate	Head	4CA 4CAT	4CAX 4CATX	Flow rate	Head
						m ³ /h	m			m ³ /h	m
100-250C	-	■	■	■	■	120 ÷ 300	73,2 ÷ 61	-	-	-	-
100-250B	-	■	■	■	■	120 ÷ 330	83,7 ÷ 67,6	-	-	-	-
100-250A	-	■	■	■	■	120 ÷ 360	93,9 ÷ 73,2	■	■	60 ÷ 204	22,3 ÷ 13,8
100-315B	-	-	-	-	-	-	-	■	■	72 ÷ 216	31,4 ÷ 17,9
100-315A	-	-	-	-	-	-	-	■	■	72 ÷ 216	36,5 ÷ 23,1
100-400C	-	-	-	-	-	-	-	■	■	84 ÷ 228	40,6 ÷ 25,8
100-400B	-	-	-	-	-	-	-	■	■	84 ÷ 240	48,7 ÷ 31,6
100-400A	-	-	-	-	-	-	-	■	■	84 ÷ 252	56 ÷ 36,7
125-250B	-	-	-	-	-	-	-	■	■	102 ÷ 252	20,2 ÷ 11,1
125-250A	-	-	-	-	-	-	-	■	■	102 ÷ 276	24 ÷ 14,7
125-315C	-	-	-	-	-	-	-	■	■	120 ÷ 348	25,8 ÷ 15,7
125-315B	-	-	-	-	-	-	-	■	■	120 ÷ 372	33 ÷ 22,2
125-315A	-	-	-	-	-	-	-	■	■	120 ÷ 372	39,6 ÷ 28,2
125-400C	-	-	-	-	-	-	-	■	■	120 ÷ 372	47,6 ÷ 33,8
125-400B	-	-	-	-	-	-	-	■	■	120 ÷ 396	54,5 ÷ 39,1
125-400A	-	-	-	-	-	-	-	■	■	120 ÷ 396	59,5 ÷ 45
150-315D	-	-	-	-	-	-	-	■	■	144 ÷ 444	28,3 ÷ 19,6
150-315C	-	-	-	-	-	-	-	■	■	144 ÷ 492	32,2 ÷ 21,8
150-315B	-	-	-	-	-	-	-	■	■	144 ÷ 540	36,3 ÷ 23,6
150-315A	-	-	-	-	-	-	-	■	■	144 ÷ 564	41 ÷ 27,2
150-400C	-	-	-	-	-	-	-	■	■	168 ÷ 564	47,8 ÷ 28,7
150-400B	-	-	-	-	-	-	-	■	■	168 ÷ 588	54,4 ÷ 34,3
150-400A	-	-	-	-	-	-	-	■	■	168 ÷ 612	60,3 ÷ 39,8
Not envisaged in the EN 733 standard											
200-315D	-	-	-	-	-	-	-	■	■	200 ÷ 800	21,7 ÷ 12,5
200-315C	-	-	-	-	-	-	-	■	■	200 ÷ 850	26,6 ÷ 14,6
200-315B	-	-	-	-	-	-	-	■	■	200 ÷ 900	33,4 ÷ 16,7
200-315A	-	-	-	-	-	-	-	■	■	200 ÷ 900	35,9 ÷ 19,8
200-400C	-	-	-	-	-	-	-	■	■	200 ÷ 800	44,1 ÷ 31,5
200-400B	-	-	-	-	-	-	-	■	■	200 ÷ 850	50,8 ÷ 36,6
200-400A	-	-	-	-	-	-	-	■	■	200 ÷ 900	58,5 ÷ 44
250-315C	-	-	-	-	-	-	-	■	■	250 ÷ 1100	25,5 ÷ 16,8
250-315B	-	-	-	-	-	-	-	■	■	250 ÷ 1170	33 ÷ 19
250-315A	-	-	-	-	-	-	-	■	■	250 ÷ 1200	35 ÷ 20
250-400D	-	-	-	-	-	-	-	■	■	250 ÷ 1300	39,9 ÷ 24,3
250-400C	-	-	-	-	-	-	-	■	■	250 ÷ 1400	45,8 ÷ 27,4
250-400B	-	-	-	-	-	-	-	■	■	250 ÷ 1500	51,7 ÷ 30,3
250-400A	-	-	-	-	-	-	-	■	■	250 ÷ 1600	57,4 ÷ 31,7



CM Series

Models list and materials

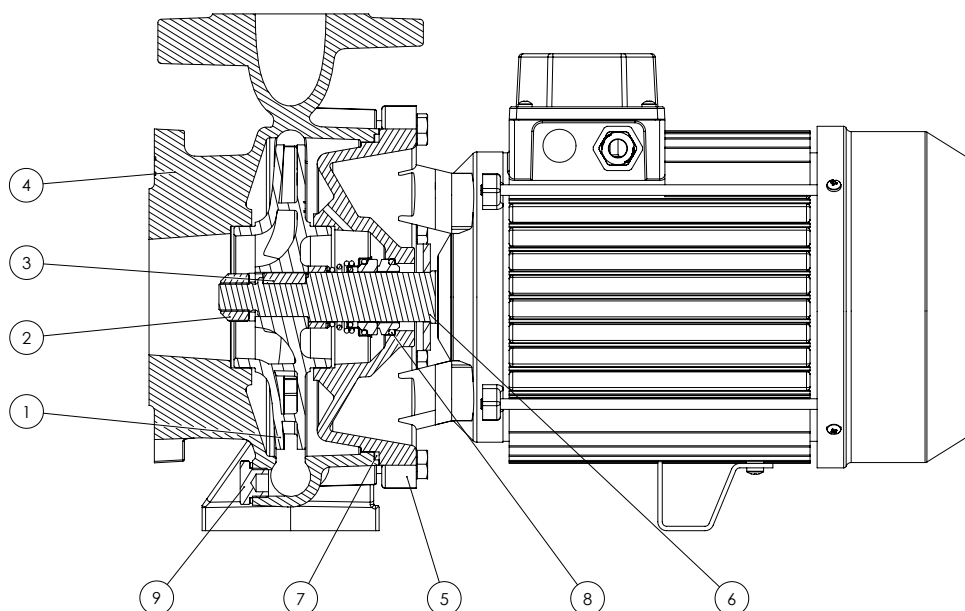

POS. N.	DENOMINATION	VERSION	MATERIAL	REFERENCE STANDARDS	
				EUROPE	USA
1	Impeller	Standard	Cast iron G20	GJL-200 (JL1030)	ASTM Class 30
		B	Bronze	CuSn10-C (CC480K)	UNS C90700
		X	Stainless steel	X5CrNiMo17-12-2/ 1.4401	AISI 316
2	Impeller lock nut and washer		Stainless steel	X5CrNiMo17-12-2/ 1.4401	AISI 316
3	Impeller key		Stainless steel	X5CrNiMo17-12-2/ 1.4401	AISI 316
4	Volute casing	Up to 80-200	Cast iron G20	GJL-200 (JL1030)	ASTM Class 30
		From 80-250	Cast iron G25	GJL-250 (JL1040)	ASTM Class 35
5	Motor bracket		Cast iron G20	GJL-200 (JL1030)	ASTM Class 30
6	Shaft extension		Stainless steel	X5CrNi18-10/ 1.4301	AISI 304
7	O-ring	Standard	NBR		
		E	EPDM		
		V	FKM		
8	Mechanical seal		(Search for the material in the mechanical seal table)		
9	Fill and drain plugs		Brass	CU ZN 40 PB2 UNI 5705/65	C37700

TYPE - 50 Hz	P2		P1	3-400V	Q (m³/h - l/min)																					
					0	30	33	36	39	42	45	48	54	60	66	72	78	84	96	108	120	132	138	144	150	
	HP	kW	kW	A	0	500	550	600	650	700	750	800	900	1000	1100	1200	1300	1400	1600	1800	2000	2200	2300	2400	2500	
H (m)																										
65-125B1	7,5	5,5	6,4	11,3	19,7	20,6	20,5	20,4	20,4	20,3	20,2	20,2	20,0	19,7	19,3	18,8	18,2	17,5	16,3	15,0						
65-125B	7,5	5,5	6,6	11,0	19,7	20,6	20,5	20,4	20,4	20,3	20,2	20,2	20,0	19,7	19,3	18,8	18,2	17,5	16,3	15,0	13,1					
65-125A1	10	7,5	8,6	15,1	24,6	25,2	25,2	25,1	25,1	25,0	24,8	24,9	24,7	24,5	24,2	23,9	23,5	23,0	22,0	20,6	18,8					
65-125A	10	7,5	8,8	14,4	24,6	25,2	25,2	25,1	25,1	25,0	24,9	24,9	24,7	24,5	24,2	23,9	23,5	23,0	22,0	20,6	18,8	16,8				
65-160C	12,5	9,2	10,1	16,8	28,9					30,6	30,5	30,3	30,0	29,6	29,1	28,5	27,9	27,2	25,3	22,9	20,2	17,5	16,0	13,9		
65-160B	15	11	12,7	20,6	33,2					35,1	35,0	34,9	34,6	34,3	33,8	33,3	32,8	32,1	30,4	28,2	25,5	22,5	21,4	20,4		
65-160A1	20	15	16,8	27,6	40,1					42,5	42,5	42,5	42,3	42,1	41,8	41,4	41,0	40,4	38,9	37,1	35,3	32,8	31,7			
65-160A	20	15	17,1	28,5	40,1					42,5	42,5	42,5	42,3	42,1	41,8	41,4	41,0	40,4	38,9	37,1	35,3	32,8	31,7	30,9		
65-200C1	20	15	16,8	27,6	44,4									46,1	45,4	44,7	44,0	43,2	42,4	40,3	37,5	33,7	28,9			
65-200C	20	15	17,0	28,3	44,4									46,1	45,4	44,7	44,0	43,2	42,4	40,3	37,5	33,7	28,9	26,8		
65-200B	25	18,5	21,2	34,8	51,7									53,9	53,4	52,7	52,0	51,3	50,4	48,6	45,9	43,0	39,4	37,1	34,6	
65-200A	30	22	25,4	41,7	60,3									61,8	61,4	61,0	60,4	59,8	59,1	57,1	54,6	51,6	48,3	46,5	44,4	
65-250B	40	30	30,8	55,3	80,6									80,6	79,5	78,4	77,1	75,7	74,1	70,4	66,1	61,0	54,7	51,0	47,3	
65-250A	50	37	37,0	69,2	91,6									91,6	90,8	89,8	88,6	87,4	85,9	82,5	77,8	72,8	67,4	64,3	60,8	57,9

TYPE - 50 Hz	P2		P1	3-400V	Q (m³/h - l/min)																				
					0	66	72	78	84	96	108	120	132	138	144	156	168	180	195	210	225	240			
	HP	kW	kW	A	0	1100	1200	1300	1400	1600	1800	2000	2200	2300	2400	2600	2800	3000	3250	3500	3750	4000			
H (m)																									
80-160E	12,5	9,2	9,8	16,3	21,5	22,9	22,5	22,1	21,6	20,8	19,9	18,9	17,7	17,2	16,6	15,3	13,7								
80-160D	15	11	12,2	20,0	25,4	27,3	27,0	26,6	26,3	25,4	24,5	23,5	22,4	21,8	21,2	19,9	18,3	16,4							
80-160C1	20	15	14,5	24,5	29,0	30,9	30,7	30,4	30,1	29,4	28,5	27,4	26,3	25,8	25,3	24,1	22,5	20,7	18,4						
80-160C	20	15	14,5	24,5	29,0	30,9	30,7	30,4	30,1	29,4	28,5	27,4	26,3	25,8	25,3	24,1	22,5	20,7	18,4						
80-160B	25	18,5	18,1	30,3	33,6	35,9	35,7	35,4	35,2	34,5	33,7	32,9	32,0	31,6	31,1	30,0	28,6	27,0	24,5	22,0					
80-160A	30	22	22	37	38	40,5	40,4	40,2	40,1	39,6	39,1	38,4	37,5	37,1	36,6	35,4	34,1	32,6	30,4	28,3	23,9				
80-200B	40	30	32,0	57,2	50,4				54,5	53,9	53,2	52,3	51,3	50,7	50,2	48,9	47,4	45,8	43,4	40,9	38,5				
80-200A	50	37	38,6	71,6	57,3				61,7	61,3	60,6	59,4	58,2	57,8	57,5	56,8	55,4	53,7	51,5	49,1	46,6	43,9			

TYPE - 50 Hz	P2		P1	3-400V	Q (m³/h - l/min)																				
					0	96	108	120	132	138	144	156	168	180	195	210	225	240	270	300	330				
	HP	kW	kW	A	0	1600	1800	2000	2200	2300	2400	2600	2800	3000	3250	3500	3750	4000	4500	5000	5500				
H (m)																									
100-160B	40	30	31,9	57,1	41,7	40,7	40,8	40,7	40,4	40,3	40,1	39,6	39,1	38,5	37,8	37,0	36,1	35,0	32,3	29,2	25,7				
100-160A	50	37	37,5	70,2	46,0	45,1	45,2	45,1	44,9	44,8	44,7	44,3	43,9	43,3	42,7	42,0	41,1	40,2	37,9	35,0	31,9				



CM-CMG-CMGX-CA-CAX ~ EN 733

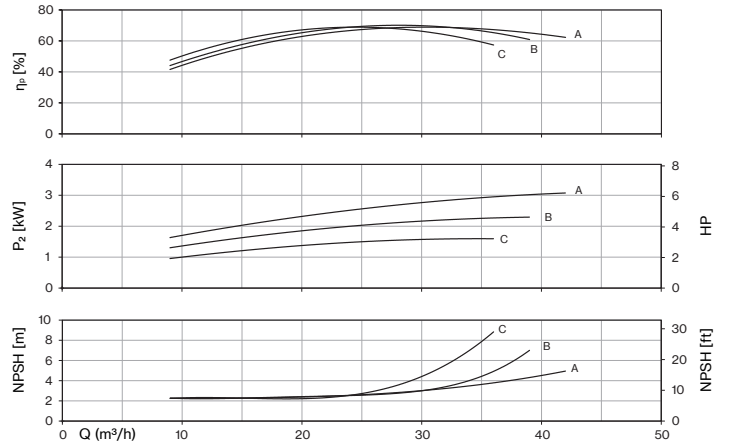
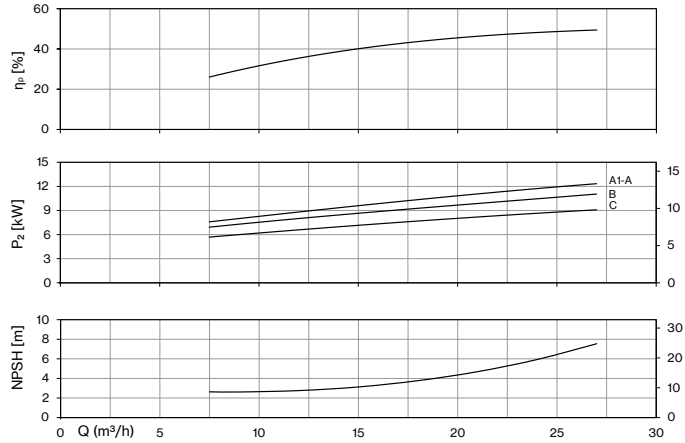
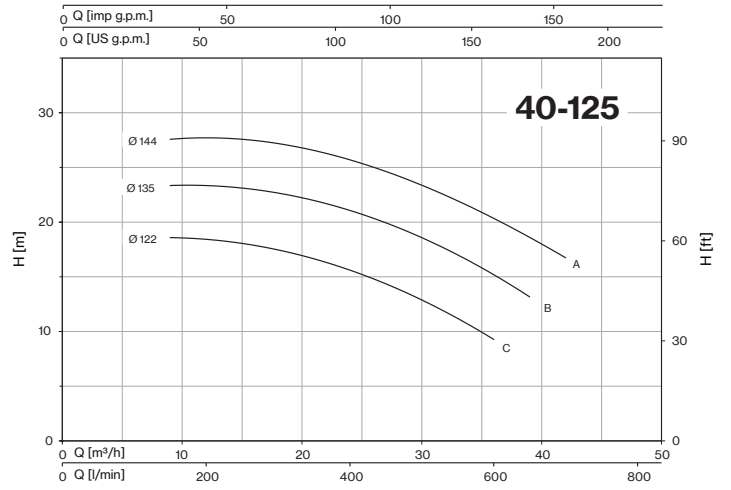
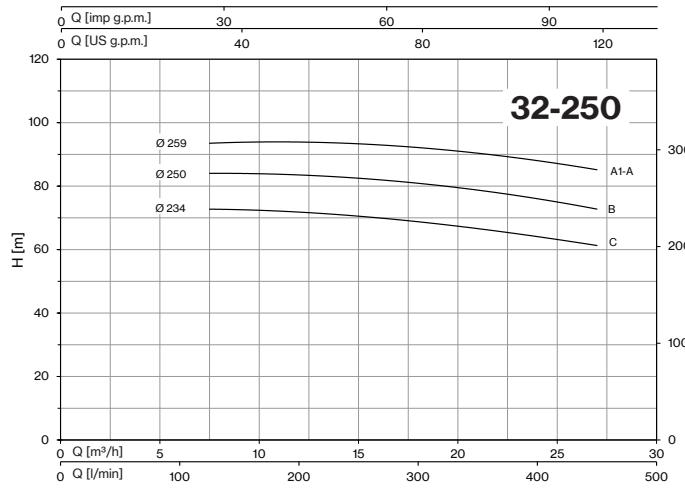
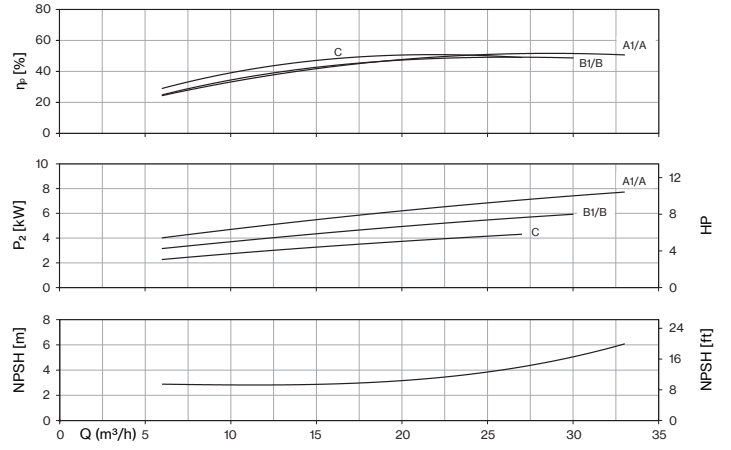
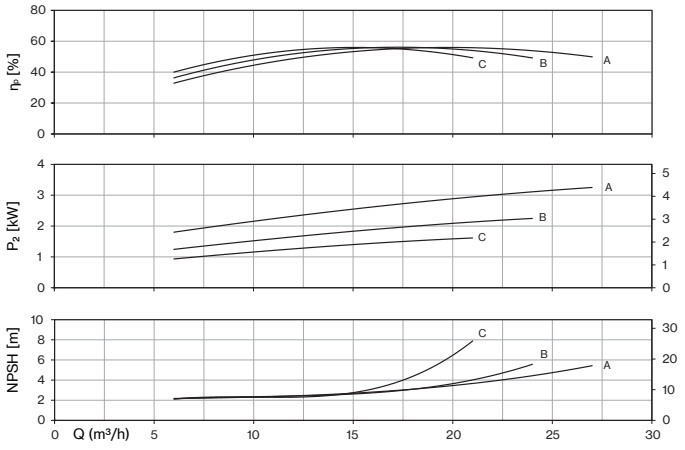
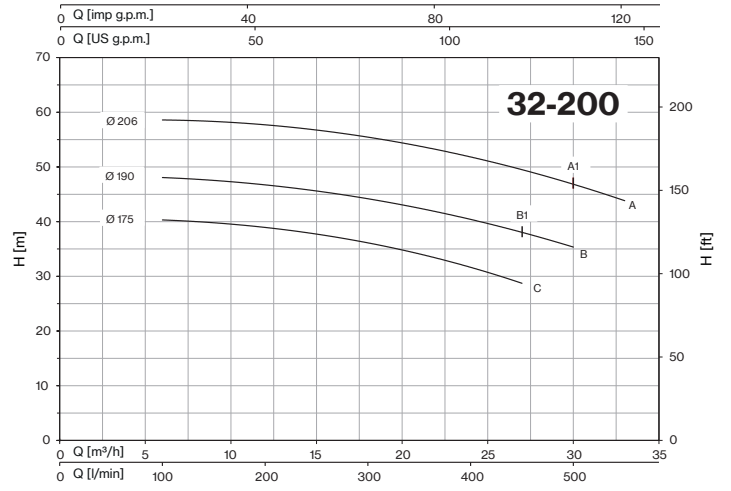
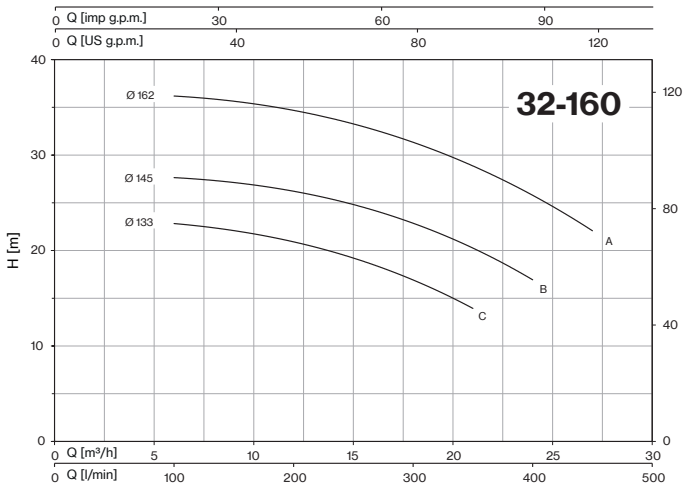

CM-CMG-CMGX-CA-CAX ~ EN 733

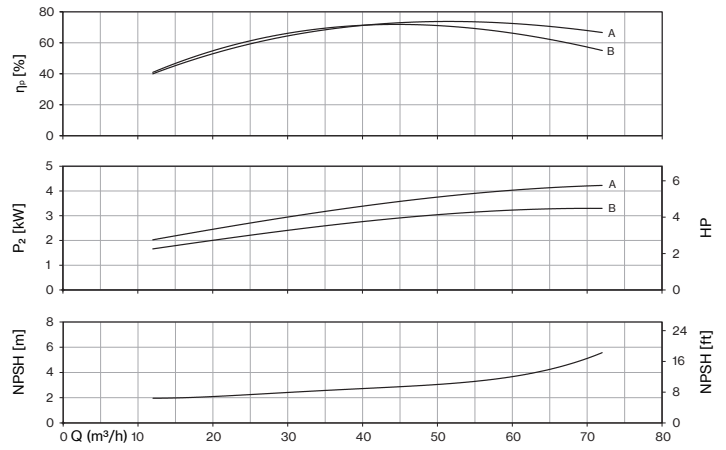
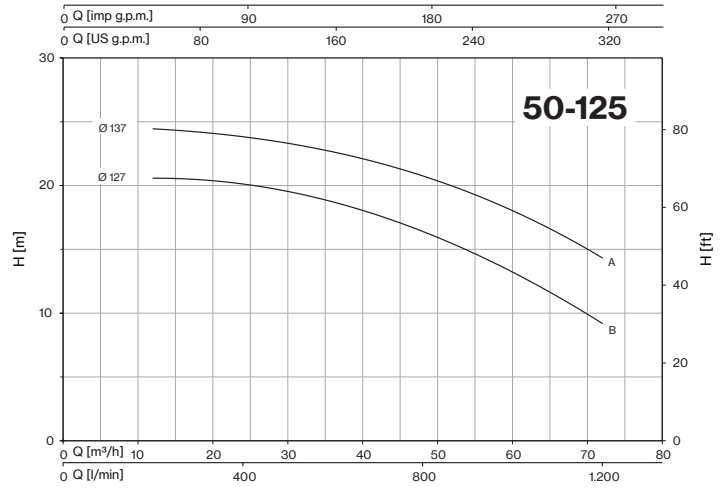
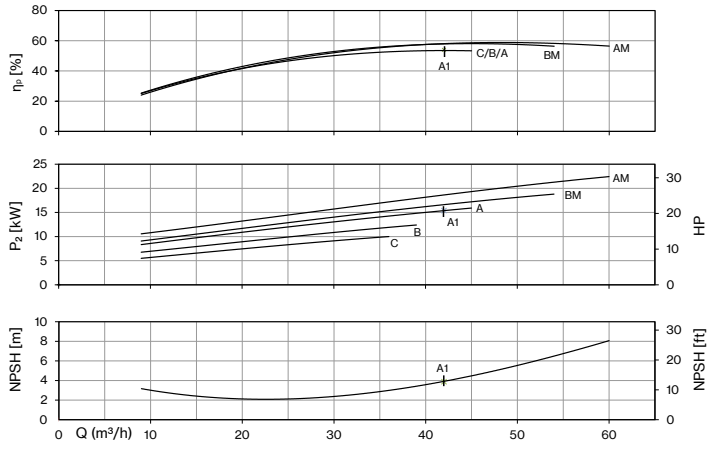
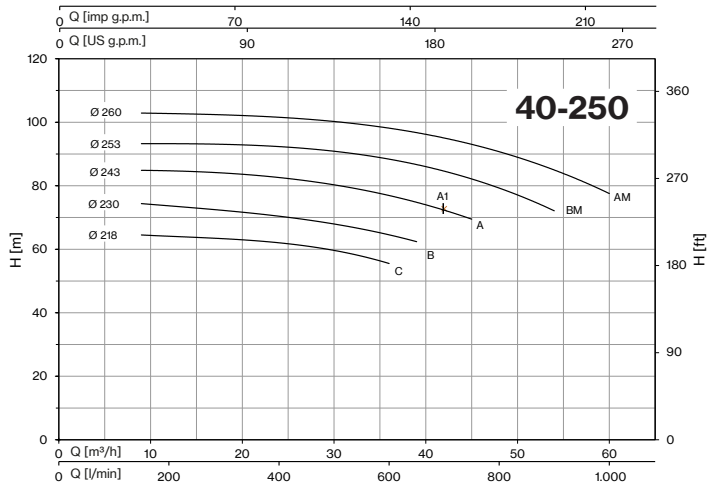
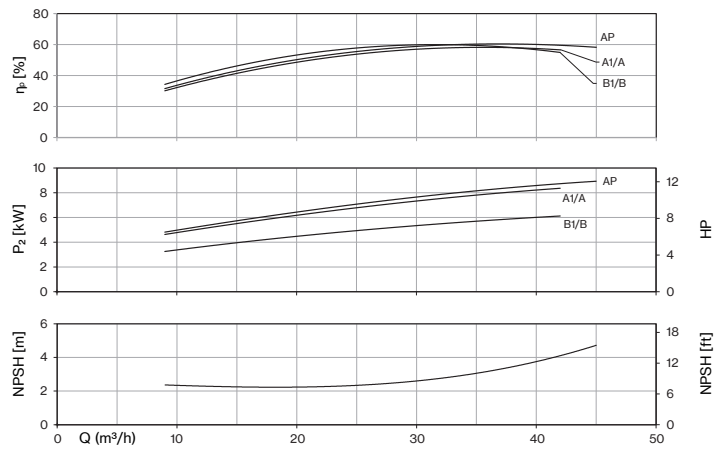
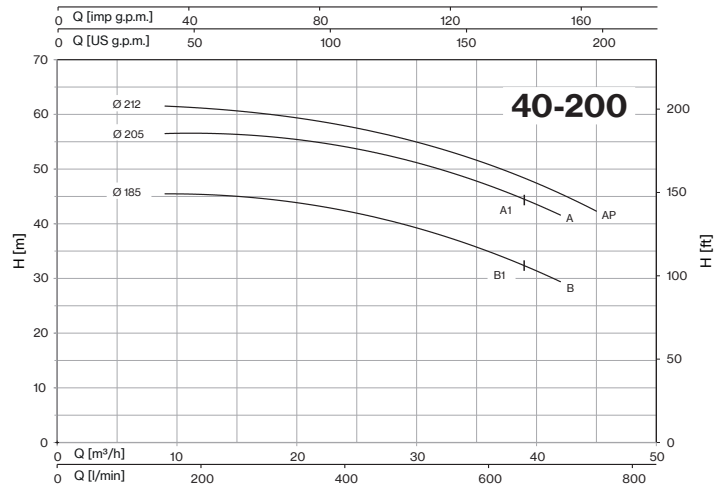
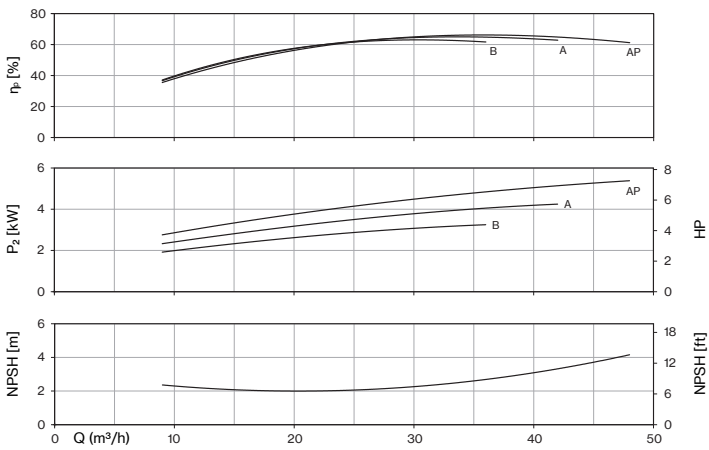
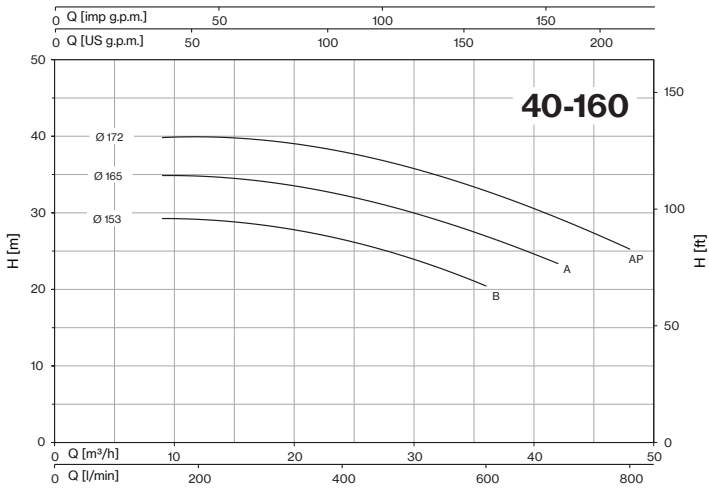

CM-CMG-CMGX-CA-CAX ~ EN 733

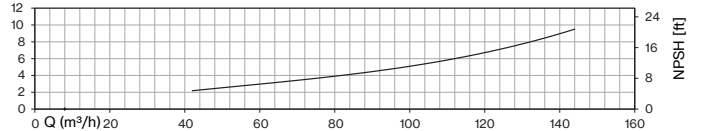
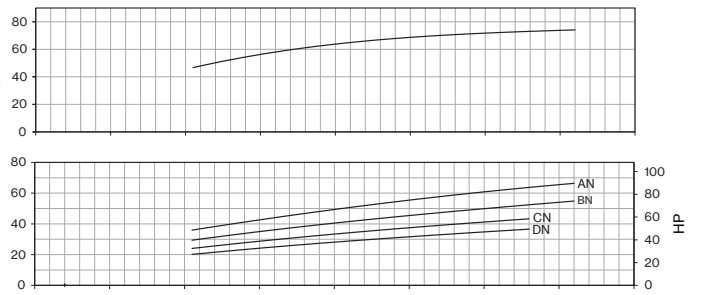
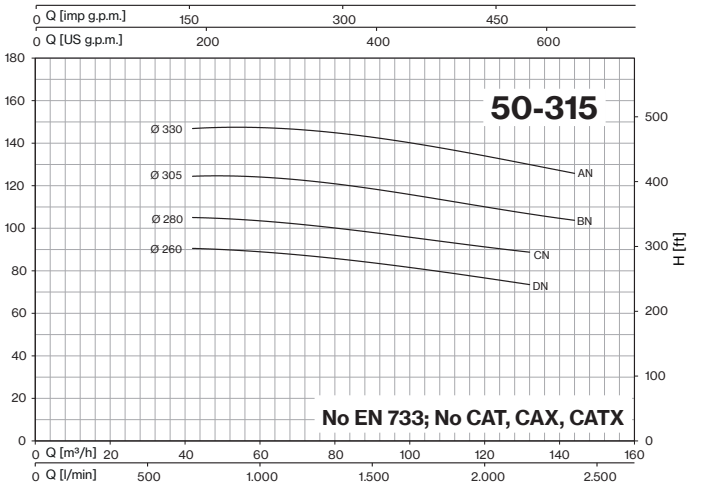
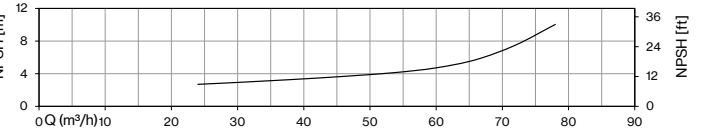
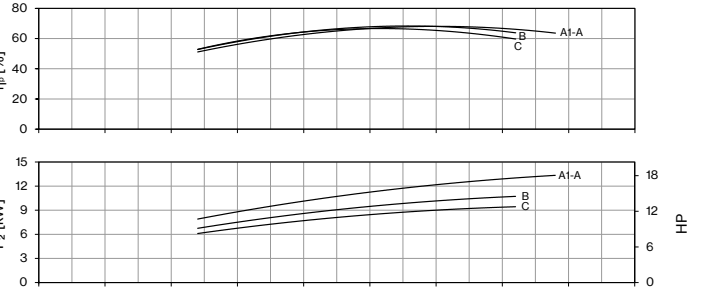
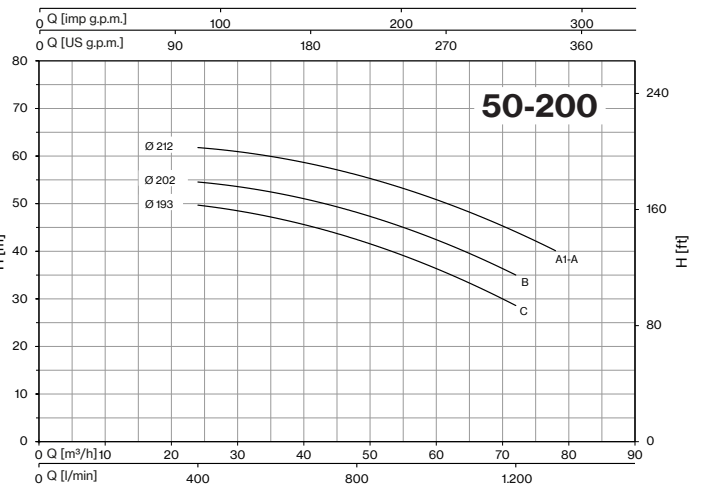
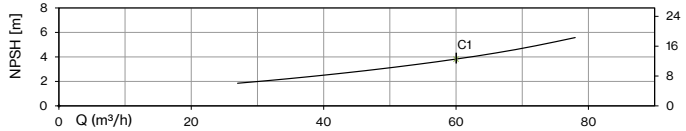
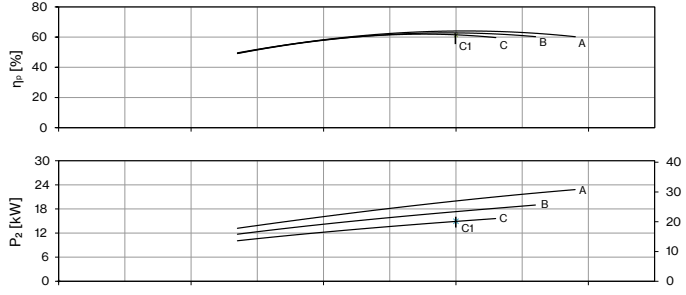
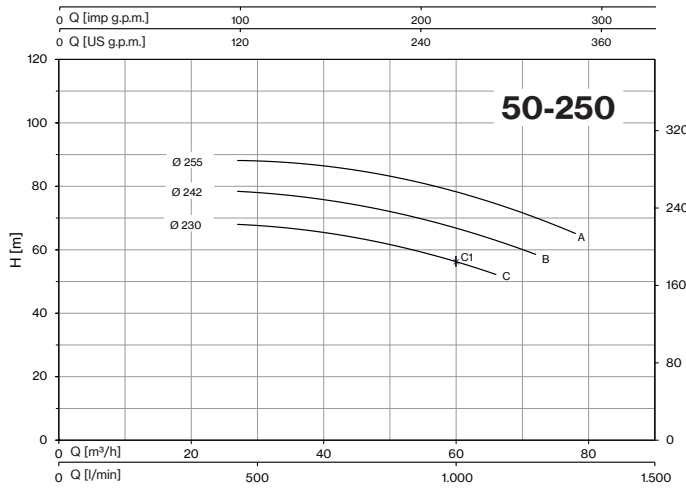
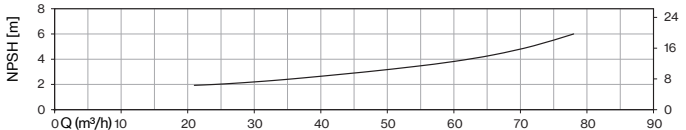
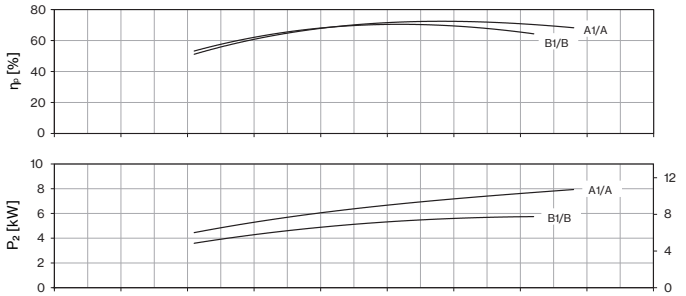
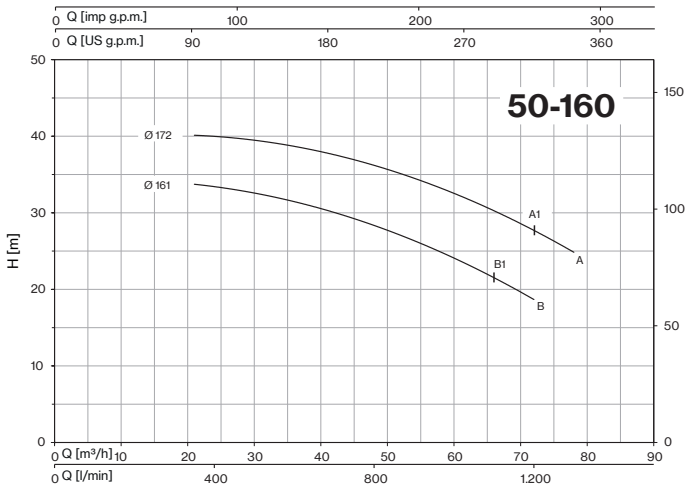

No EN 733; No CAT, CAX, CATX



CM-CMG-CMGX-CA-CAX ~ EN 733

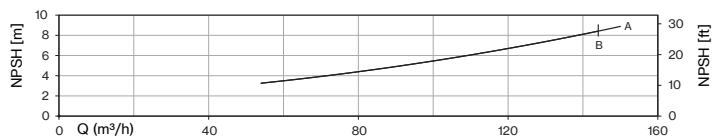
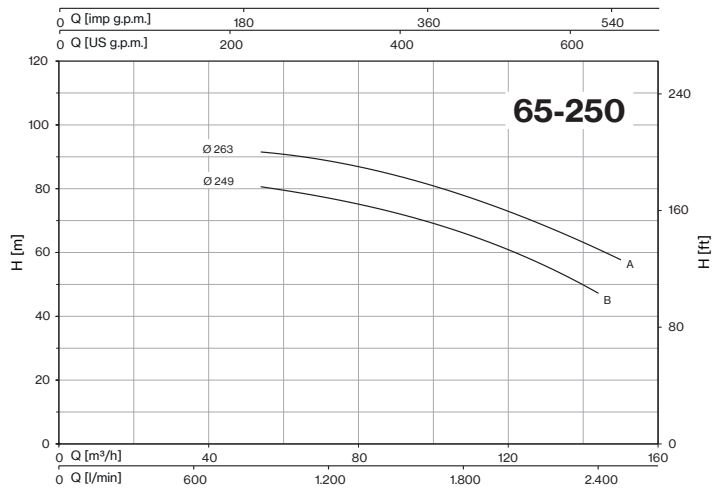
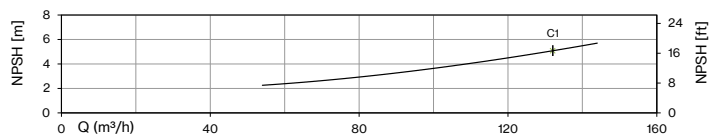
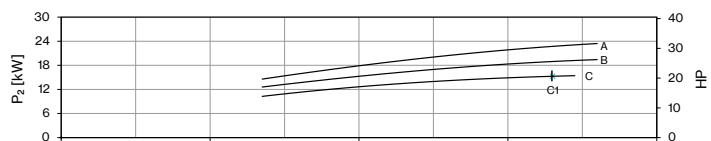
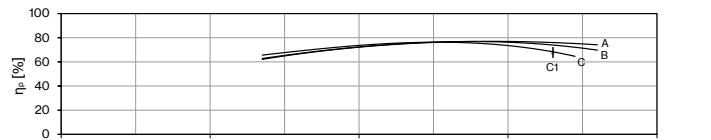
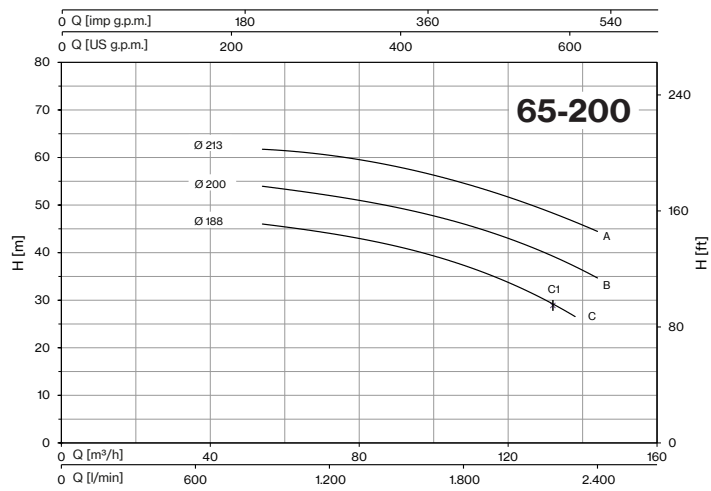
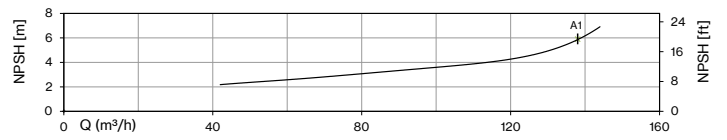
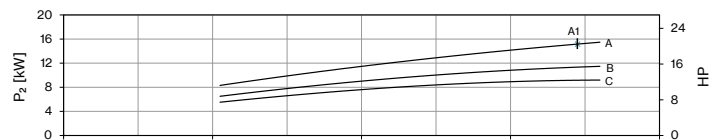
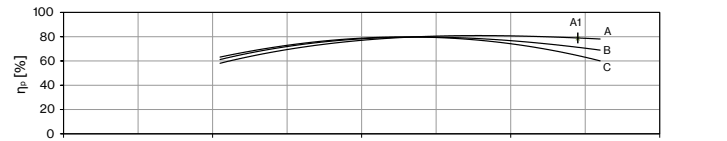
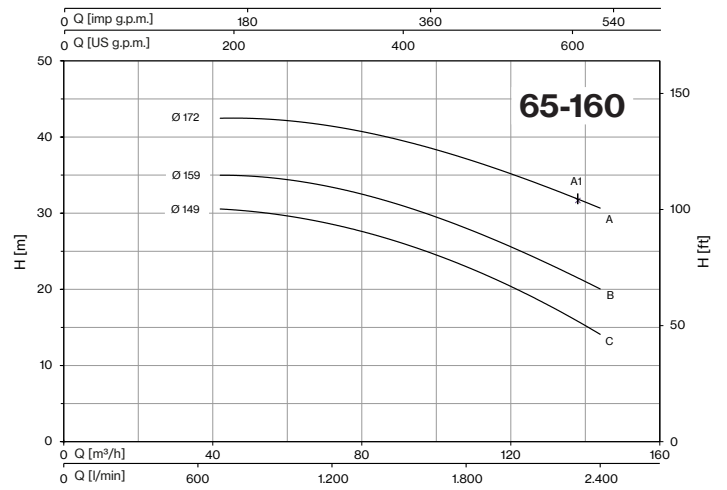
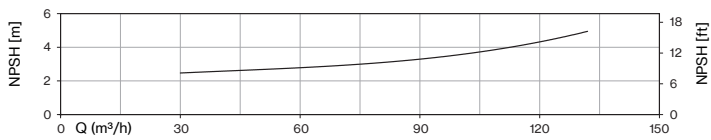
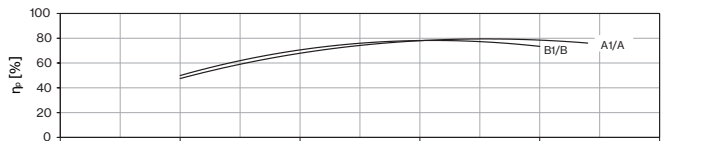
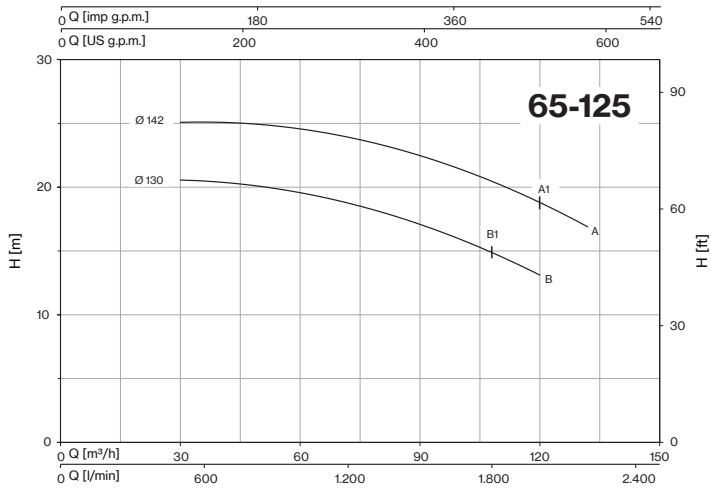

CM-CMG-CMGX-CA-CAX ~ EN 733

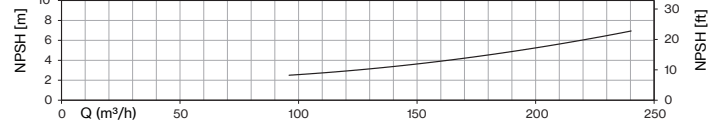
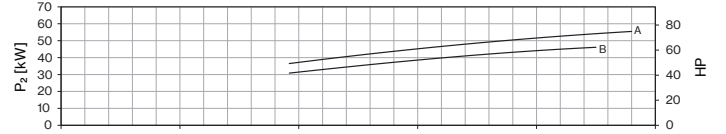
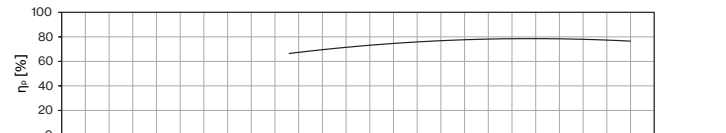
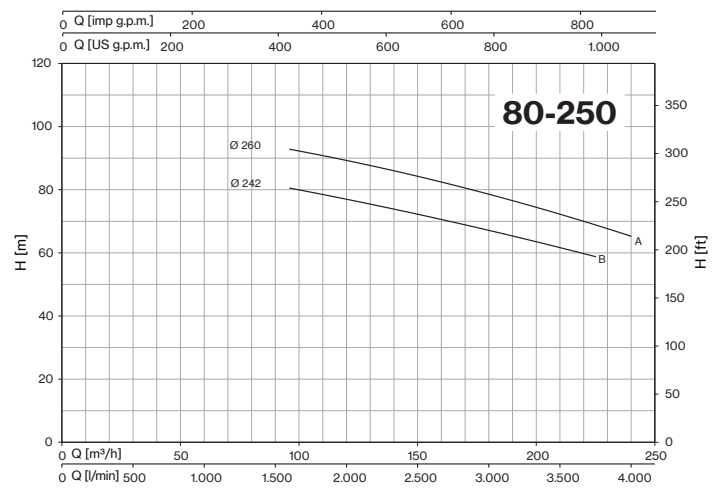
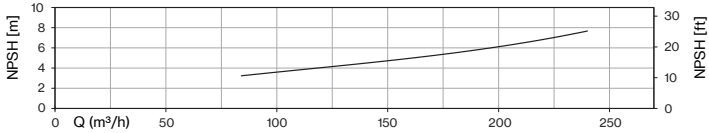
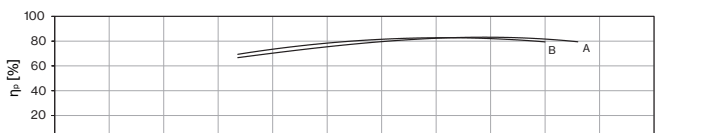
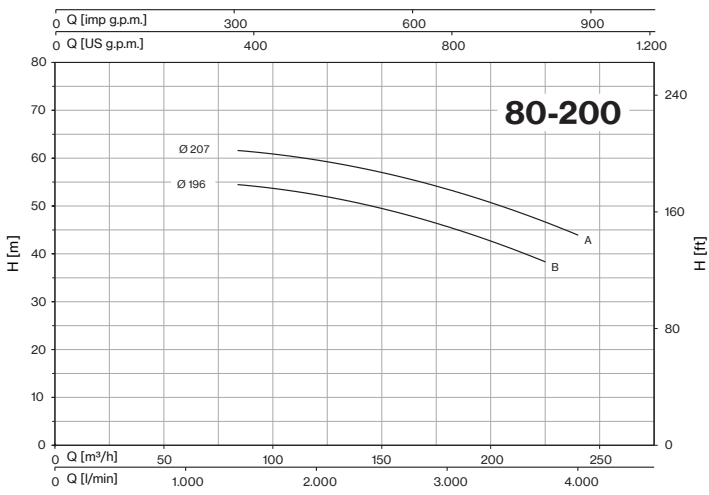
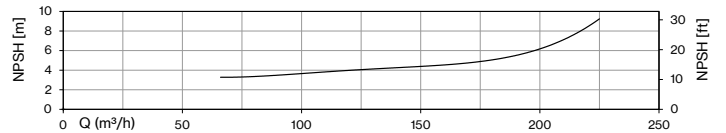
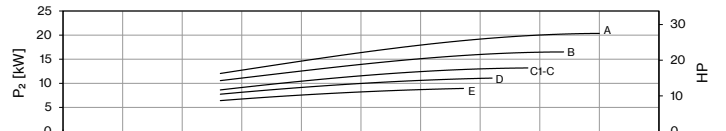
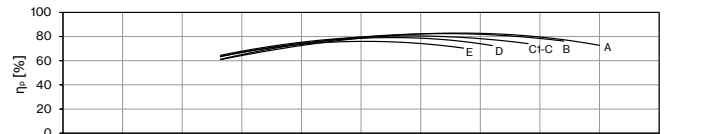
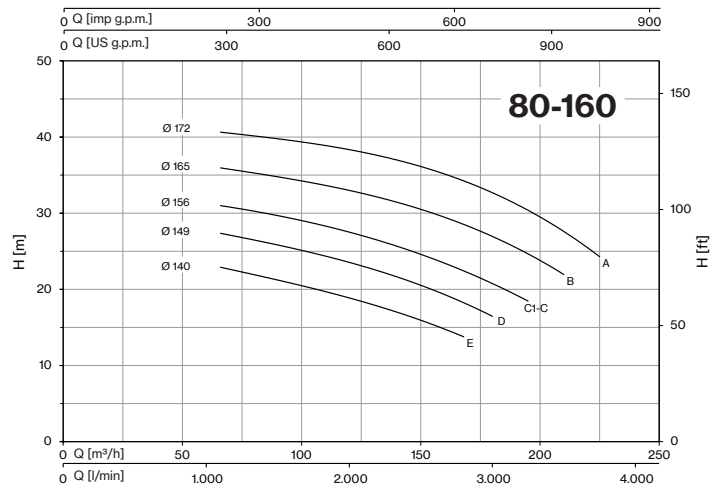
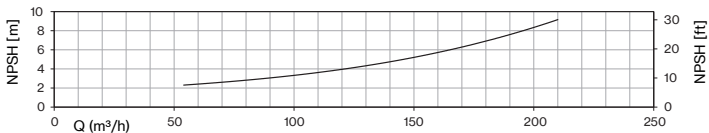
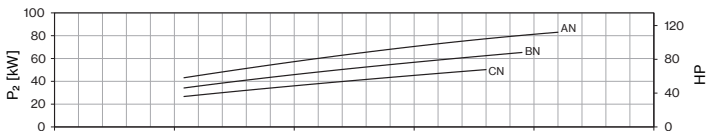
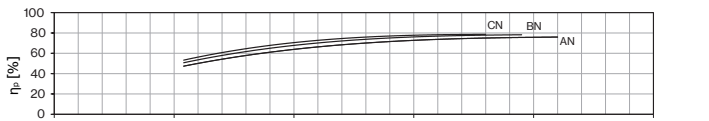
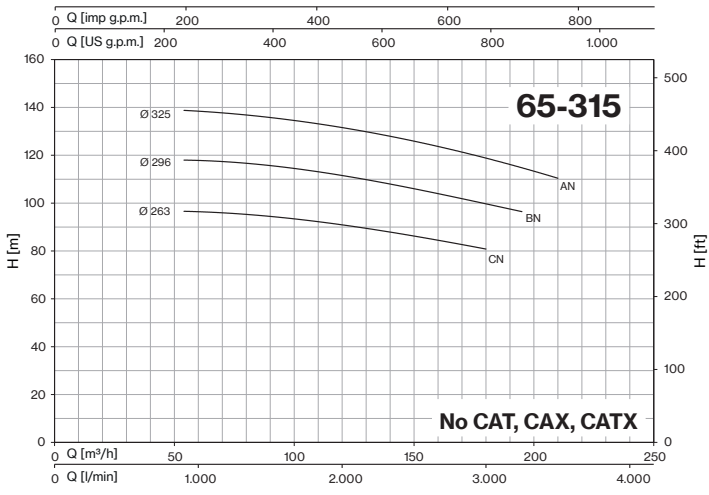

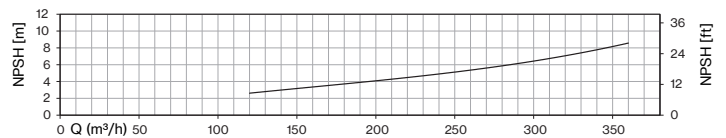
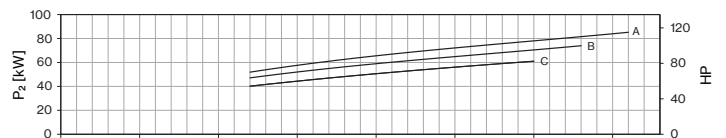
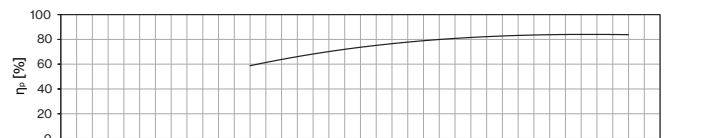
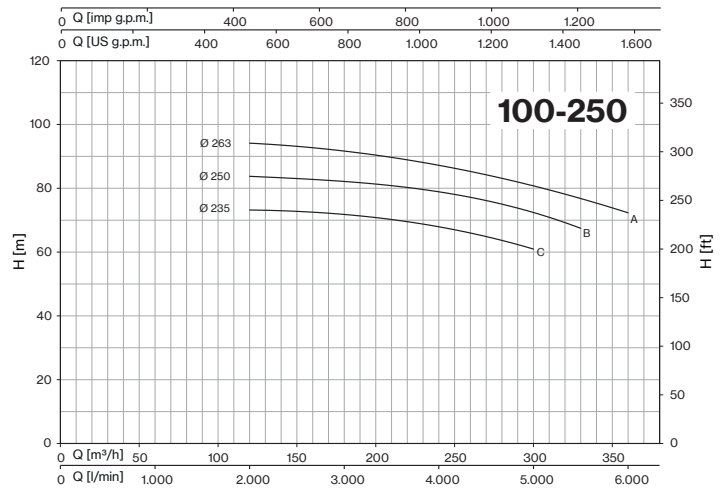
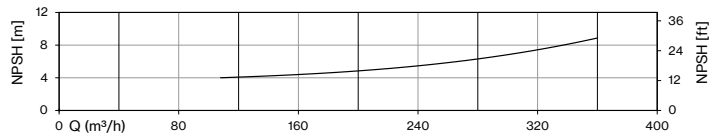
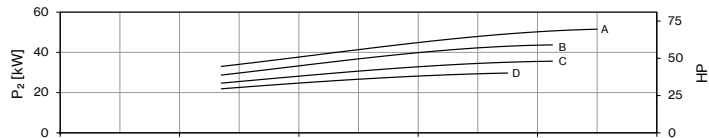
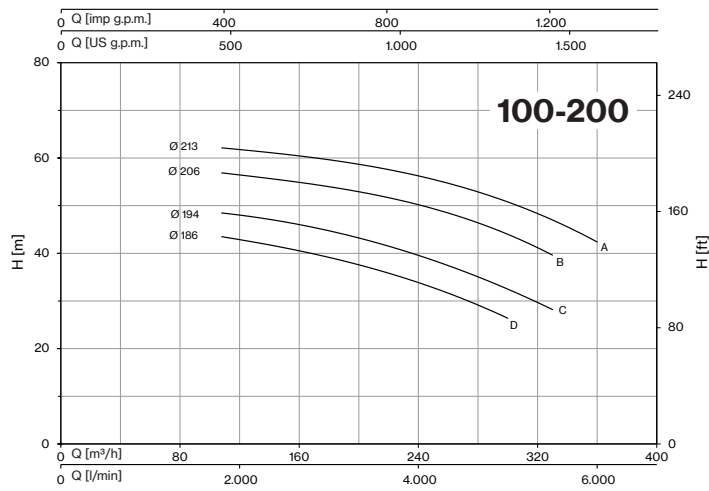
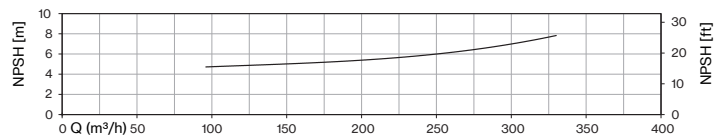
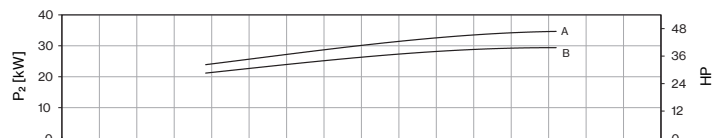
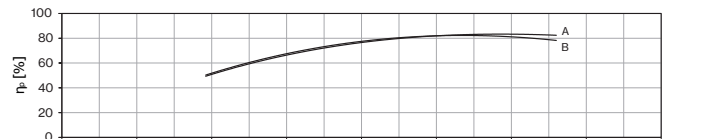
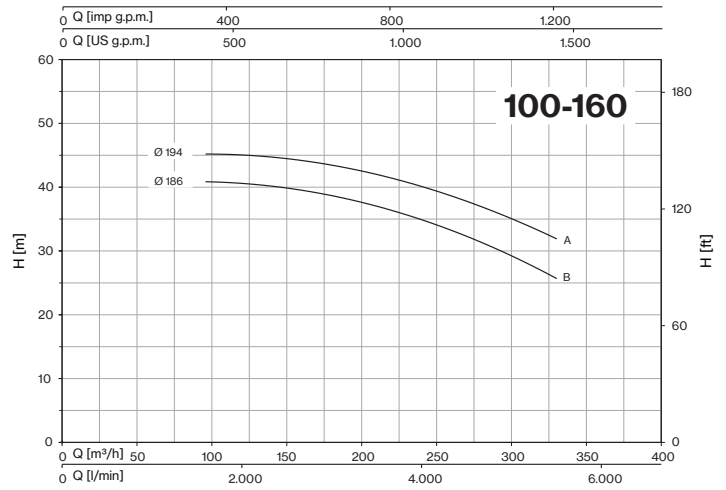
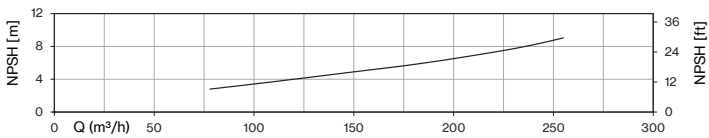
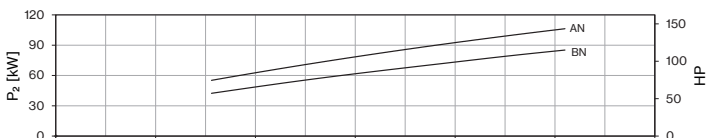
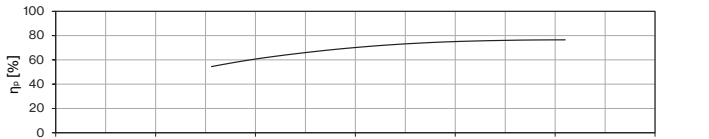
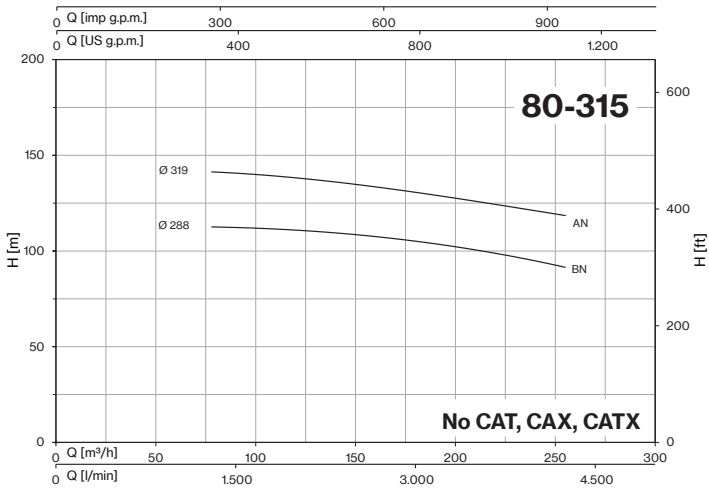

CM-CMG-CMGX-CA-CAX ~ EN 733



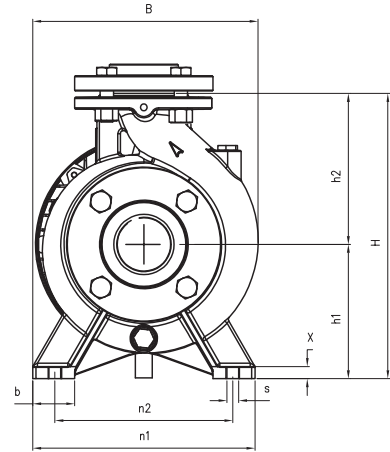
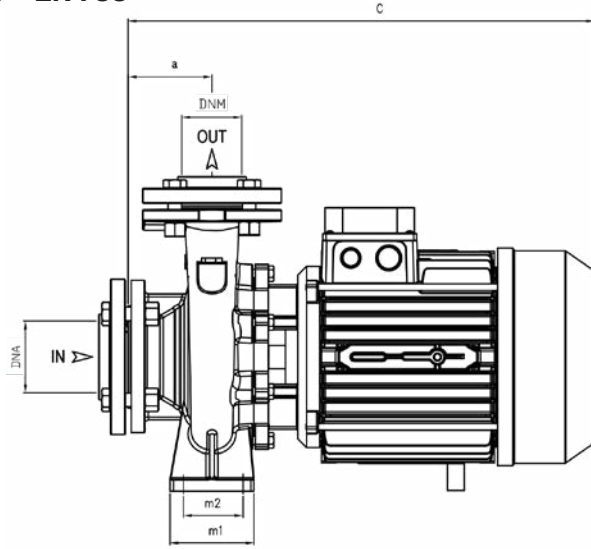

CM ~ EN 733



TYPE		MEC	DIMENSIONS (mm)																			
-1	-3		a	h1	h2	m1	m2	n1	n2	b	x	s	C	B	H	DNA	DNM	I	L	M	-1	-3
32-160 C	32-160 C	90	80	132	160	100	70	240	190	50	12	14	530	240	292	50	32	551	250	341	41	41
32-160 B	32-160 B	90	80	132	160	100	70	240	190	50	12	14	530	240	292			551	250	341	44	44
-	32-160 A	90	80	132	160	100	70	240	190	50	12	14	530	240	292			551	250	341	-	47
32-200 C	-	112	80	160	180	100	70	240	190	50	12	14	574	268	340			602	263	395	65,5	-
-	32-200 C	100	80	160	180	100	70	240	190	50	12	14	540	268	340			602	263	395	-	56,5
-	32-200 B1	112	80	160	180	100	70	240	190	50	12	14	520	268	340			627	287	408	-	65,5
-	32-200 B	132	80	160	180	100	70	240	190	50	12	14	565	268	340			627	287	408	-	72
-	32-200 A1	112	80	160	180	100	70	240	190	50	12	14	520	268	340			627	287	408	-	72
-	32-200 A	132	80	160	180	100	70	240	190	50	12	14	565	268	340			627	287	408	-	79
-	32-250 C	132	100	180	225	125	95	320	250	65	12	14	625	305	405			666	346	471	-	101,5
-	32-250 B	132	100	180	225	125	95	320	250	65	14	14	625	305	405	666	346	471	-	105,5		
-	32-250 A1	132	100	180	225	125	95	320	250	65	14	14	670	305	405	810	354	480	-	110		
-	32-250 A	160	100	180	225	125	95	320	250	65	14	14	695	305	405	810	354	480	-	135,5		
40-125 C	40-125 C	90	80	112	140	100	70	210	160	50	12	14	535	220	252	65	40	551	250	341	41,5	41,5
40-125 B	40-125 B	90	80	112	140	100	70	210	160	50	12	14	535	220	252			551	250	341	44	44
-	40-125 A	90	80	112	140	100	70	210	160	50	12	14	535	220	252			551	250	341	-	47,5
40-160 B	-	100	80	132	160	100	70	240	190	50	12	14	535	245	292			551	250	341	56	-
-	40-160 B	100	80	132	160	100	70	240	190	50	12	14	535	245	292			551	250	341	-	52
40-160 A	-	112	80	132	160	100	70	240	190	50	15	14	579	245	292			602	263	395	64,5	-
-	40-160 A	100	80	132	160	100	70	240	190	50	15	14	535	245	292			602	263	395	-	56,5
-	40-160 AP	112	80	132	160	100	70	240	190	50	15	14	579	245	292			627	287	408	-	63
-	40-200 B1	112	100	160	180	100	70	265	212	50	15	14	597	273	340			627	287	408	-	68
-	40-200 B	132	100	160	180	100	70	265	212	50	15	14	590	273	340			627	287	408	-	74,5
-	40-200 A1	112	100	160	180	100	70	265	212	50	15	14	597	273	340	627	287	408	-	74		
-	40-200 A	132	100	160	180	100	70	265	212	50	15	14	590	273	340	627	287	408	-	81		
-	40-200 AP	132	100	160	180	100	70	265	212	50	15	14	628	273	340	666	346	471	-	93,5		
-	40-250 C	132	100	180	225	125	95	320	250	65	15	14	630	322	405	666	346	471	-	100,5		
-	40-250 B	132	100	180	225	125	95	320	250	65	15	14	630	322	405	666	346	471	-	105		
-	40-250 A1	132	100	180	225	125	95	320	250	65	15	14	675	322	405	810	354	480	-	109,5		
-	40-250 A	160	100	180	225	125	95	320	250	65	15	14	700	322	405	810	354	480	-	135		
-	40-250 BM	132	100	180	225	125	95	320	250	65	15	14	750	332	405	810	354	480	-	150		
-	40-250 AM	160	100	180	225	125	95	320	250	65	15	14	750	332	405	810	354	480	-	160,5		
50-125 B	-	100	100	132	160	100	70	240	190	50	12	14	525	250	292	65	50	602	263	395	57,5	-
-	50-125 B	100	100	132	160	100	70	240	190	50	12	14	560	250	292			602	263	395	-	53,5
50-125 A	-	112	100	132	160	100	70	240	190	50	12	14	610	250	292			602	263	395	65,5	-
-	50-125 A	100	100	132	160	100	70	240	190	50	12	14	560	250	292			602	263	395	-	57,5
-	50-160 B1	112	100	160	180	100	70	265	212	50	12	14	597	270	340			627	287	408	-	68,5
-	50-160 B	132	100	160	180	100	70	265	212	50	12	14	590	270	340			627	287	408	-	74,5
-	50-160 A1	112	100	160	180	100	70	265	212	50	12	14	597	270	340			627	287	408	-	74,5
-	50-160 A	132	100	160	180	100	70	265	212	50	12	14	590	270	340			627	287	408	-	81
-	50-200 C	132	100	160	200	100	70	265	215	50	12	14	635	290	360			666	346	471	-	98
-	50-200 B	132	100	160	200	100	70	265	215	50	12	14	635	290	360			666	346	471	-	102,5
-	50-200 A1	132	100	160	200	100	70	265	215	50	12	14	680	290	360	810	354	480	-	107		
-	50-200 A	160	100	160	200	100	70	265	215	50	12	14	705	290	360	810	354	480	-	132,5		



TYPE		MEC																				
-1	-3		a	h1	h2	m1	m2	n1	n2	b	x	s	C	B	H	DNA	DNM	I	L	M	-1	-3
-	50-250 C1	132	100	180	225	125	95	320	250	65	14	14	680	332	405	65	50	810	354	480	-	113,5
-	50-250 C	160	100	180	225	125	95	320	250	65	14	14	705	332	405			810	354	480	-	139
-	50-250 B	160	100	180	225	125	95	320	250	65	14	14	750	332	405			810	354	480	-	154
-	50-250 A	160	100	180	225	125	95	320	250	65	14	14	750	332	405			810	354	480	-	164
-	65-125 B1	112	100	160	180	125	95	280	212	65	14	14	612	280	340	80	65	627	287	408	-	70
-	65-125 B	132	100	160	180	125	95	280	212	65	14	14	605	280	340			627	287	408	-	76,5
-	65-125 A1	112	100	160	180	125	95	280	212	65	14	14	612	280	340			627	287	408	-	76,5
-	65-125 A	132	100	160	180	125	95	280	212	65	14	14	605	280	340			627	287	408	-	83
-	65-160 C	132	100	160	200	125	95	280	212	65	14	14	635	290	360			666	346	471	-	99,5
-	65-160 B	132	100	160	200	125	95	280	212	65	14	14	635	290	360			666	346	471	-	103,5
-	65-160 A1	132	100	160	200	125	95	280	212	65	14	14	680	290	360			810	354	480	-	107,5
-	65-160 A	160	100	160	200	125	95	280	212	65	14	14	705	290	360			810	354	480	-	135
-	65-200 C1	132	100	180	225	125	95	320	250	65	14	14	680	330	405			810	354	480	-	113
-	65-200 C	160	100	180	225	125	95	320	250	65	14	14	705	330	405			810	354	480	-	138,5
-	65-200 B	160	100	180	225	125	95	320	250	65	14	14	750	330	405			810	354	480	-	153
-	65-200 A	160	100	180	225	125	95	320	250	65	14	14	750	330	405			810	354	480	-	163,5
-	65-250 B	180	100	200	250	160	120	360	280	80	16	19	820	370	450	920	420	625	-	203,5		
-	65-250 A	180	100	200	250	160	120	360	280	80	16	19	860	370	450	920	420	625	-	226		
-	80-160 E	132	125	180	225	125	95	320	250	65	14	14	665	330	405	100	80	810	354	480	-	110
-	80-160 D	132	125	180	225	125	95	320	250	65	14	14	665	330	405			810	354	480	-	114
-	80-160 C1	132	125	180	225	125	95	320	250	65	14	14	710	330	405			810	354	480	-	118
-	80-160 C	160	125	180	225	125	95	320	250	65	14	14	735	330	405			810	354	480	-	143
-	80-160 B	160	125	180	225	125	95	320	250	65	14	14	780	330	405			810	354	480	-	157,5
-	80-160 A	160	125	180	225	125	95	320	250	65	14	14	780	330	405			810	354	480	-	168
-	80-200 B	180	125	180	250	125	95	345	280	65	16	14	840	355	430			920	420	625	-	200
-	80-200 A	180	125	180	250	125	95	345	280	65	16	14	880	355	430			920	420	625	-	222
-	100-160 B	180	125	200	280	160	120	360	280	80	18	18	842	390	480	125	100	920	420	625	-	208
-	100-160 A	180	125	200	280	160	120	360	280	80	18	18	882	390	480	125	100	920	420	625	-	230,5

DIMENSIONS (mm)				
DN	D	K	holes	
			n°	Ø
32	140	100	4	18
40	150	110	4	18
50	165	125	4	18
65	185	145	4	18
80	200	160	8	18
100	220	180	8	18
125	250	210	8	18

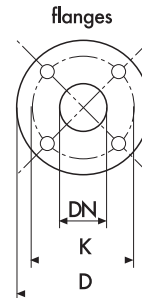

TYPE	LOTS			
	TRUCK		CONTAINER	
	PALLET (cm)	N° pumps	PALLET (cm)	N° pumps
32-160	80×120×155	24	80×120×190	30
32-200 (C)	80×120×155	24	80×120×180	24
32-200 (A) (A1) (B) (B1)	100×120×140	18	100×120×185	24
32-250 (A)	85×110×120	6	85×110×170	9
32-250 (B) (C)	80×120×120	6	80×120×170	9
40-125	80×120×155	24	80×120×190	30
40-160	80×120×155	24	80×120×190	30
40-200	100×120×140	18	100×120×185	24
40-250 (A)	85×110×120	6	85×110×170	9
40-250 (B) (BM) (C)	80×120×120	6	80×120×170	9
50-125	80×120×120	24	80×120×180	24
50-160	100×120×140	18	100×120×185	24
50-200 (A)	85×110×120	6	85×110×170	9
50-200 (B) (C)	80×120×120	6	80×120×170	9
50-250	80×120×120	6	80×120×170	9
65-125	100×120×140	18	100×120×185	24
65-160	85×110×120	6	85×110×170	9
65-200	85×110×120	6	85×110×170	9
65-250	85×110×130	4	85×110×190	6
80-160	85×110×120	6	85×110×170	9
80-200	85×110×130	4	85×110×190	6
100-160	85×110×130	4	85×110×190	6



CM Serie-Mechanical seal and bearings

MECHANICAL SEAL	PUMP MODEL	SHAFT Ø		STANDARD MATERIAL	OPTIONAL			
					E	V	2E	2V
	32-160, 40-125	20mm	Rotating face Stationary face Elastomer	Ceramic Graphite NBR	Ceramic Graphite EPDM	- - -	SiC SiC EPDM	SiC SiC FKM
	40-250M	28mm	Rotating face Stationary face Elastomer	Ceramic Graphite EPDM	- - -	- - -	SiC SiC EPDM	SiC SiC FKM
	32-200, 32-250, 40-160, 40-160P, 40-200, 40-200P, 40-250, 50-125, 50-160, 50-200, 50-250, 65-125, 65-160, 65-200, 80-160	28mm	Rotating face Stationary face Elastomer	Ceramic Graphite NBR	Ceramic Graphite EPDM	Ceramic Graphite FKM	SiC SiC EPDM	SiC SiC FKM
	65-250, 80-200, 100-160	40mm	Rotating face Stationary face Elastomer	CrNi-steel Graphite NBR	CrNi-steel Graphite EPDM	CrNi-steel Graphite FKM	SiC SiC EPDM	SiC SiC FKM

BEARINGS	PUMP MODEL	TYPE	
	32-200C, 40-160B, 40-160A, 50-125B, 50-125A	6204-ZZ	6206-ZZ C3
	32-160C, 32-160B, 32-160A, 40-125C, 40-125B, 40-125A	6205-ZZ C3	6203-ZZ
	1- 32-200C, 32-200B1, 32-200B, 32-200A1, 32-200A, 32-250C, 32-250B, 1- 40-160A, 40-160AP, 40-200B1, 40-200B, 40-200A1, 40-200A, 40-200AP, 40-250C, 40-250B, 1- 50-125A, 50-160B1, 50-160B, 50-160A1, 50-160A, 50-200C, 50-200B, 65-125B1, 65-125B, 65-125A1, 65-125A, 65-160C, 65-160B, 80-160E, 80-160D	6206-ZZ C3	6306-ZZ C3
	32-250A1, 40-250A1, 50-200A1, 50-200C1, 65-160A1, 65-200C1, 80-160C1	6308-ZZ C3	6306-ZZ C3
	32-250A, 40-250A, 40-250BM, 40-250AM, 50-200A, 50-250C, 50-250B, 50-250A, 65-160A, 65-200C, 65-200B, 65-200A, 80-160C, 80-160B, 80-160A	6308-ZZ C3	6309-ZZ C3
	65-250B, 65-250A, 80-200B, 80-200A, 100-160B, 100-160A	6309-ZZ C3	6310-ZZ C3