

Kiekis	Aprašymas
1	<p data-bbox="225 159 424 185"><b>MAGNA1 50-80 F</b></p>  <p data-bbox="619 488 1305 510"><b>Atkreipkite dėmesį! Paveikslėlyje parodytas produktas gali skirtis nuo tikrojo</b></p> <p data-bbox="225 517 497 539">Produkto Nr.: <a href="#">99221334</a></p> <p data-bbox="225 607 1460 707">The Grundfos MAGNA1 circulator pump is the simple option for a job well done. With its high energy efficiency the product lives up to the EuP 2015 regulations ensuring substantial savings on electricity, and with its intuitive, user-friendly interface and maintenance-free design, MAGNA1 is the ideal circulator pump for basic performance needs in applications where basic system control and monitoring are desired.</p> <p data-bbox="225 748 1401 797">With this range of circulator pumps, everything from setup to basic control and monitoring are made easy. The pump is maintenance-free due to the canned-rotor type design.</p> <p data-bbox="225 804 1455 853">MAGNA1 offers the possibility of monitoring the pump via the fault relay output. The digital start/stop input remotely controls the pump.</p> <p data-bbox="225 864 995 887">The pump communicates wirelessly with the Grundfos GO Remote app.</p> <p data-bbox="225 896 1134 918">MAGNA1 can work as main pump in both heating and cooling applications, including:</p> <ul data-bbox="225 954 620 1099" style="list-style-type: none"> <li>• Mixing loops</li> <li>• Heating surfaces</li> <li>• Air-conditioning surfaces</li> <li>• Ground-source heat pump systems</li> <li>• Smaller chiller applications.</li> </ul> <p data-bbox="225 1133 1441 1182">MAGNA1 is a single-phase pump and characterised by having the controller and operating panel integrated in the control box.</p> <p data-bbox="225 1191 1042 1214">The pump housing is available in both cast-iron and stainless-steel versions.</p> <p data-bbox="225 1223 1449 1272">The composite rotor can is carbon-fibre reinforced, the bearing plate and rotor cladding are made of stainless steel and the stator housing is made of aluminium.</p> <p data-bbox="225 1281 624 1303">The power electronics are air-cooled.</p> <p data-bbox="225 1368 1393 1440">The pump incorporates a 4-pole synchronous, permanent-magnet motor (PM motor). This motor type is characterised by higher efficiency than a conventional asynchronous squirrel-cage motor. The pump speed is controlled by an integrated frequency converter.</p>

# 99221334 MAGNA1 50-80 F

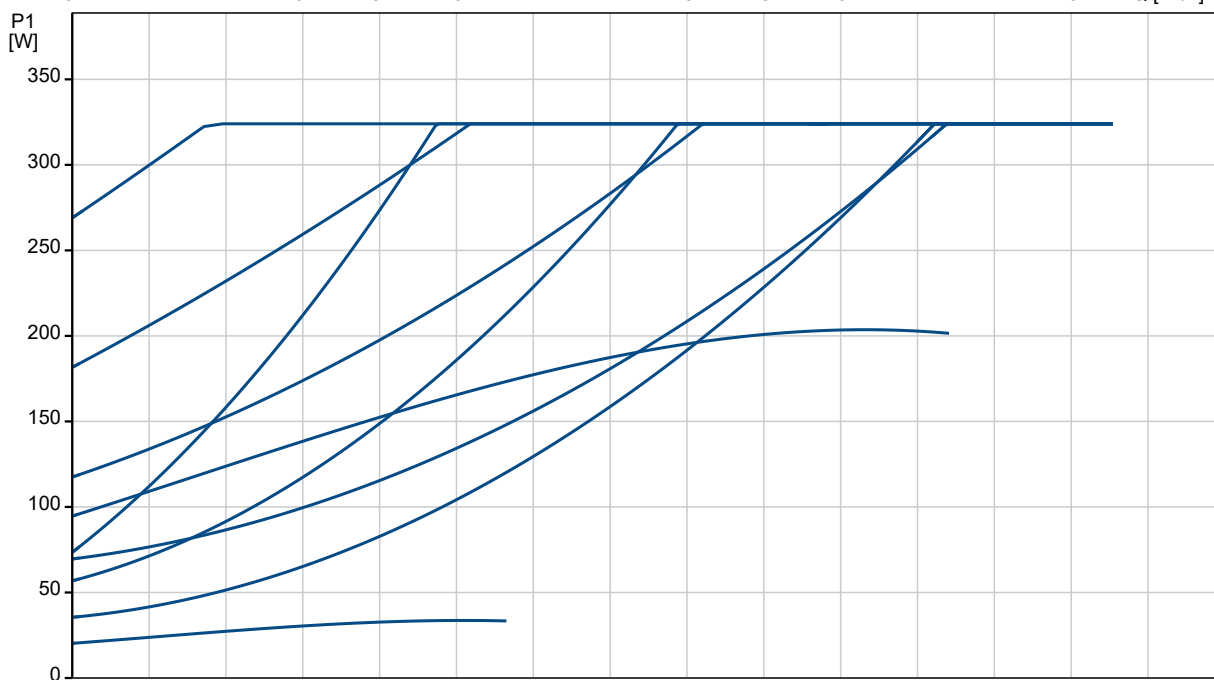

Aprašymas	Vertė
<b>Bendra informacija:</b>	
Produkto pavadinimas:	MAGNA1 50-80 F
Produkto Nr.:	99221334
EAN numeris:	5712608943072
<b>Techniniai duomenys:</b>	
Maks. slėgio aukštis:	80 dm
TF klasė:	110
Sertifikatai ant vardinės plokštelės:	CE, VDE, EAC, CN ROHS, WEEE
Modelis:	C
<b>Medžiagos:</b>	
Siurblio korpusas:	Ketus
Siurblio korpusas:	EN-GJL-250
Siurblio korpusas:	ASTM A48-250B
Darbaratis:	PES 30%GF
<b>Irengimas:</b>	
Aplinkos temperatūros intervalas:	0 .. 40 °C
Maksimalus darbinis slėgis:	10 bar
Standartinis flanšas:	DIN
Vamzdžio jungtis:	DN 50
Slėgis:	PN 6/10
Montažinis ilgis:	240 mm
<b>Skystis:</b>	
Siurbiamas skystis:	Vanduo
Skysčio temperatūros diapazonas:	-10 .. 110 °C
Skysčio temperatūra eksploataavimo metu:	60 °C
Tankis:	983.2 kg/m <sup>3</sup>
<b>Elektrotechniniai duomenys:</b>	
Naudojama galia P1:	20.91 .. 331 W
Elektros tinklo dažnis:	50 / 60 Hz
Nominali įtampa:	1 x 230 V
Maksimali vartojama srovė:	0.22 .. 1.48 A
Korpuso klasė (IEC 34-5):	X4D
Izoliacijos klasė (IEC 85):	F
<b>Kita:</b>	
Energija (EEI):	0.20
Neto masė:	17.4 kg
Bendra masė:	19.7 kg
Tiekimo tūris:	0.046 m <sup>3</sup>
Suomijos LVI Nr.:	4615194
Kilmės šalis:	DE
Muitinės kodas:	84137030

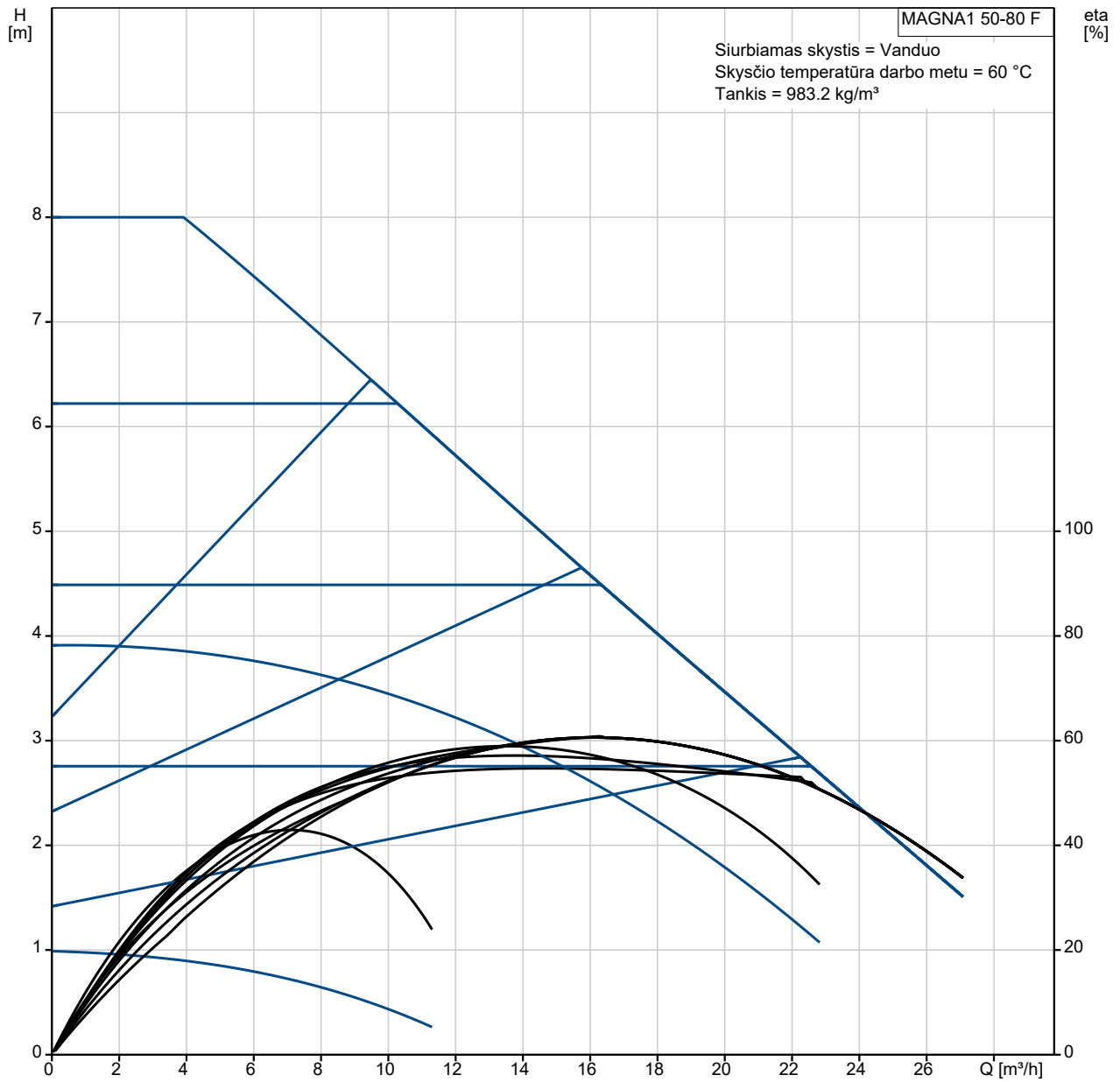
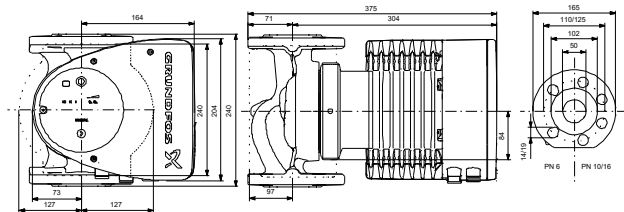
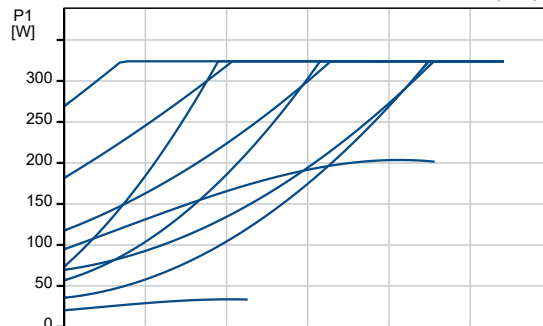
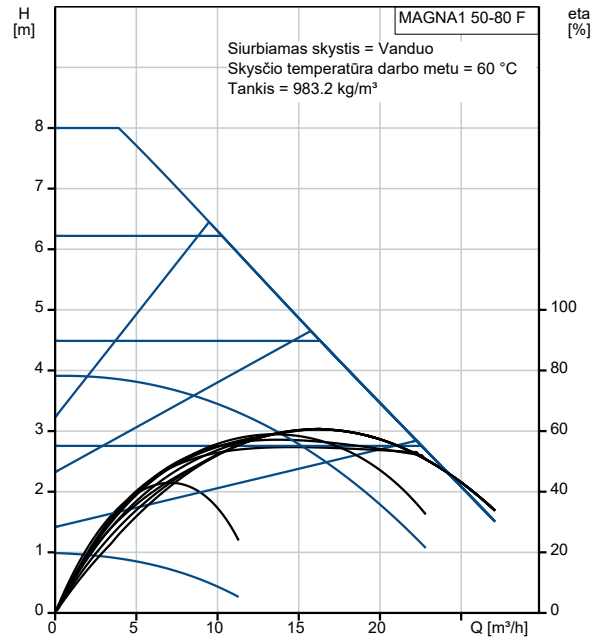

Example of mains-connected motor with mains switch, backup fuse and additional protection

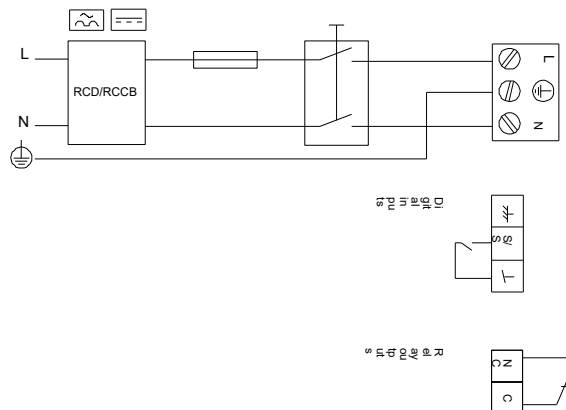

# 99221334 MAGNA1 50-80 F

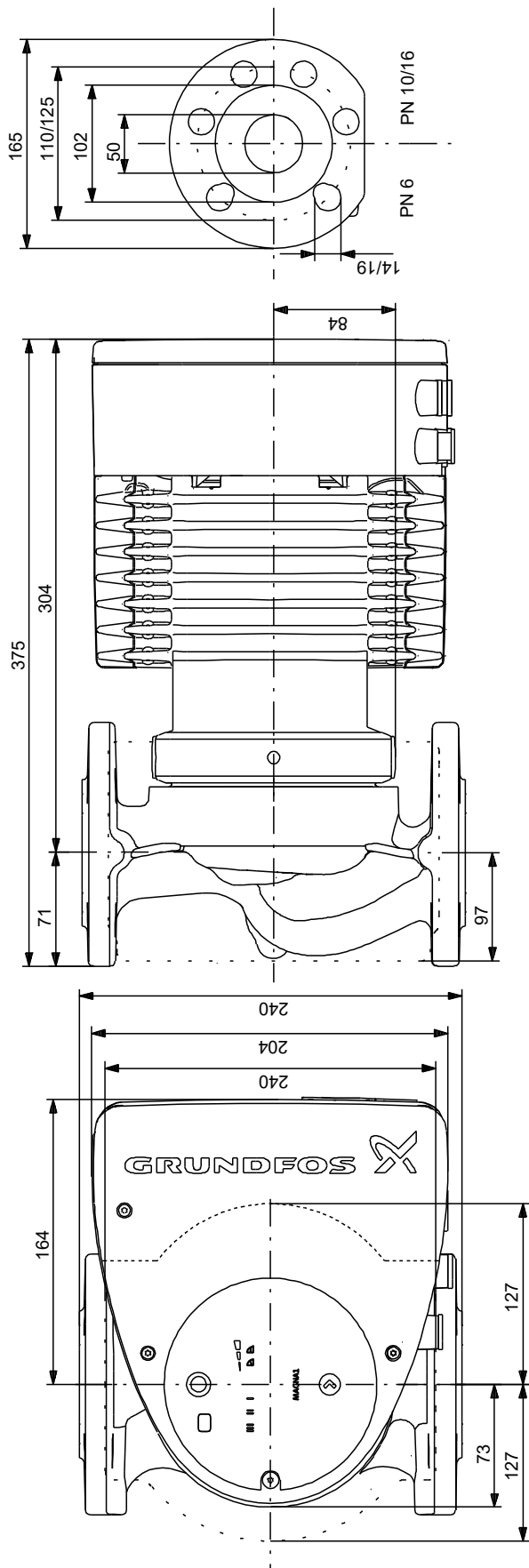

Atkreipkite dėmesį! Visi matmenys, jei nenurodyta kitaip, pateikti milimetrais.  
 Atsakomybės apribojimas: šiame supaprastintame matmenų brėžinyje neparodytos visos detalės.

# 99221334 MAGNA1 50-80 F

Example of mains-connected motor  
with mains switch, backup fuse and additional protection

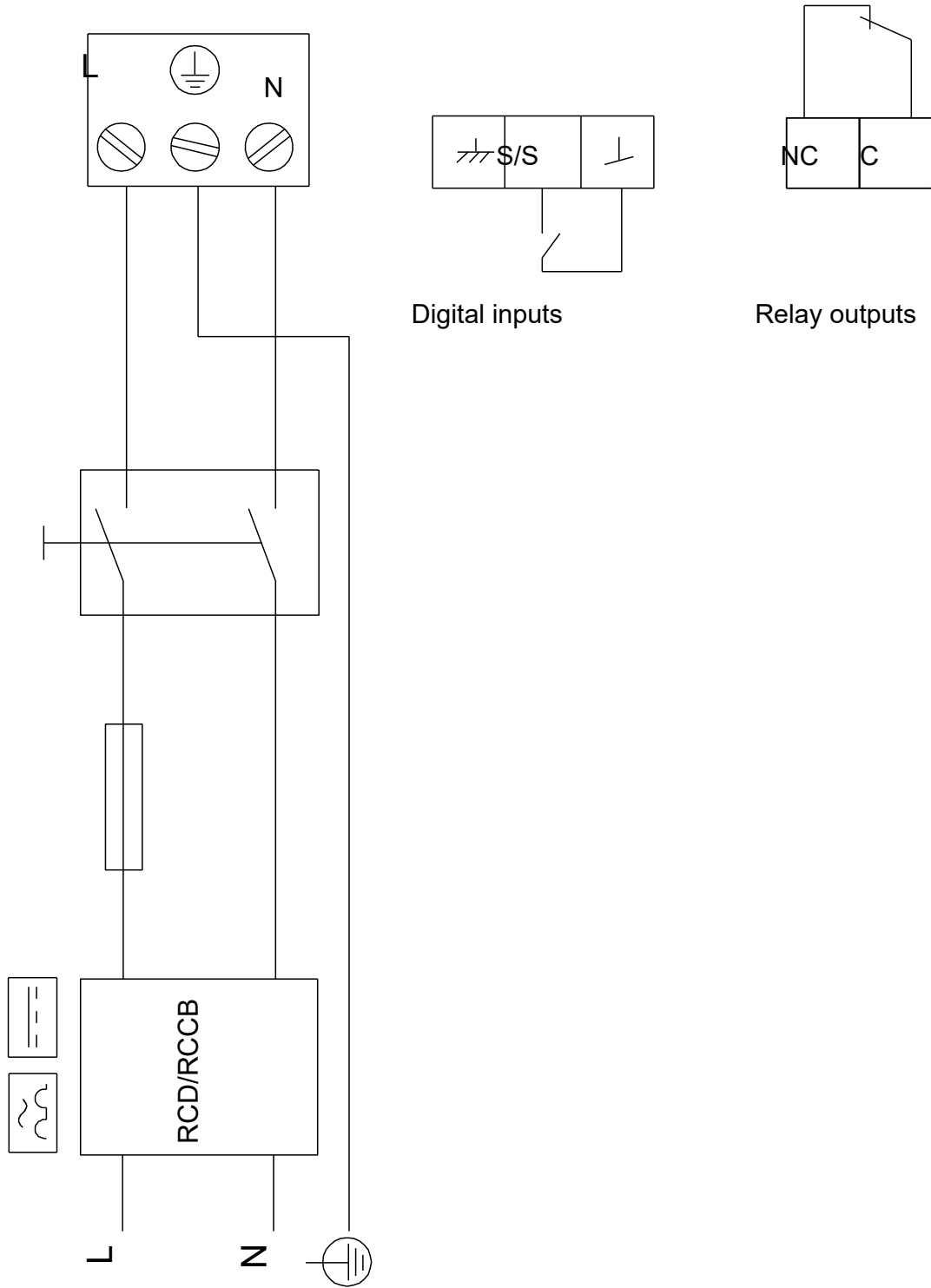

Atkreipkite dėmesį! Visi matmenys, jei nenurodyta kitaip, pateikti milimetrais.