

Company name  
 Respons. Department  
 Person in charge  
 Phone number  
 Fax no  
 E-mail address

Receiver	From

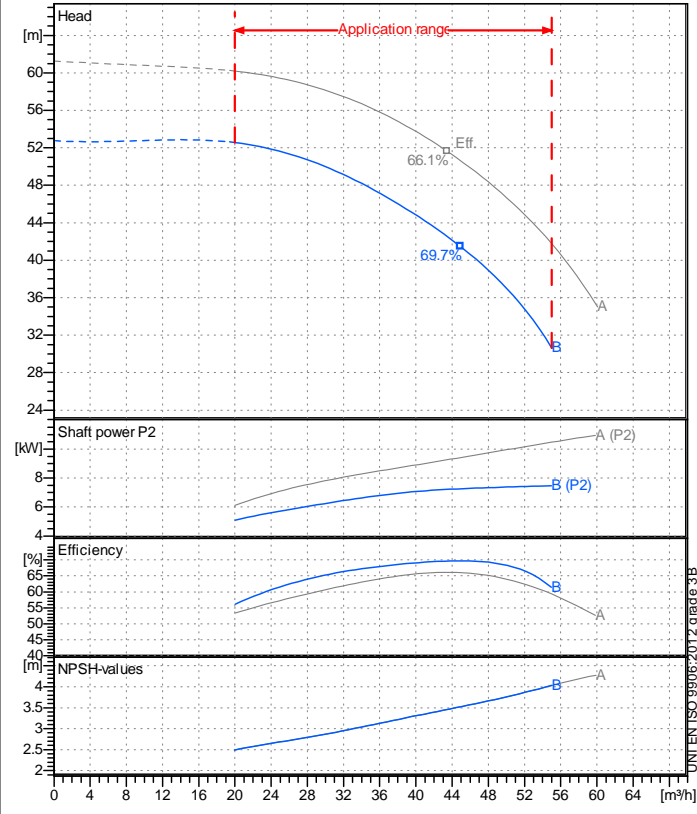

### Operating data specification

Nominal flow	m³/h 0
Nominal head	m 0
Static head	m 0
NPSH - v value of plant	m 0
Inlet pressure	bar 0.09793
Fluid	Water, pure
Operating temperature t A	°C 20
Density at t A	kg/dm³ 0.9983
Kin. viscosity at t A	mm²/s 1.005

### Pump

Pump name		IRX40-200NB	
Size		65/40/200	
MEI (Reg. 547/2002 EU) >		0,4	
Speed 1/min	2900	No of stages	1
Impeller type			
Flow	Nominal	m³/h	
	Max-	m³/h 55	
	Min-	m³/h 20	
Head	Nominal	m	
	Max-	m 52.6	
	Min-	m 30.6	
Head H(Q=0)	m 52.8		
NPSH 3%	m		
Max. working pressure	bar 5.17		
Shaft power	kW		
Efficiency	%		
Max absorbed power	kW 7.4646		

### Materials Pump

Shaft	Duplex Stainless steel (1.4362)
Impeller	Precision cast Stainless steel AISI 316 (1.4408)
Pump body	Cast Stainless steel AISI 316 (1.4408)
Seal disc	Cast Stainless steel AISI 316 (1.4408)
Gasket	Natural fiber
Mechanical seal	Q1Q1VG (SiC/SiC/FPM rubber)

### Dimensions in mm

a	100	z1	261	DNM	DNA		
b	50	z2	216	C	88	C	122
d	12			D	150	D	185
f	504			DN	40	DN	65
h1	160			K	110	K	145
h2	180			n°	4 x 19 mm		8 x 19 mm
m1	100						
m2	70						
n1	265						
n2	212						
s	14						
w	108						
x1	320						
x2	280						

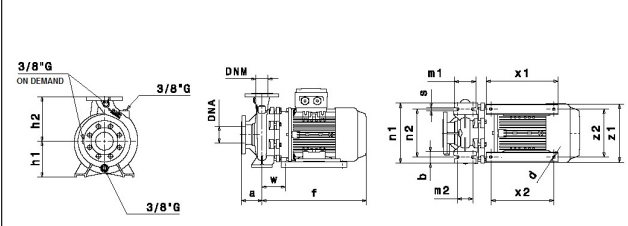
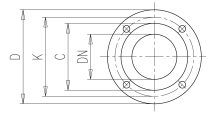

<b>Motor</b>	Manufacturer / Type	SAER	132-2P-10	
Efficiency	IEC 60034-30	IE3		
Rated power	kW 7.5	Efficiency 4/4	90.7 %	
Number of poles	2	Frame size	132	
Electric current	A 14.4 A	Speed	1/min 2949	
Electric voltage	V 400 V	3~	Hz 50	
Starting mode	Unknown			
Degree of protection	IP 55	Insulation class	F	

Remarks:				
Project	Project ID	Created by	Created on	Last update
			<b>2022-03-09</b>	

<b>Receiver</b>	<b>From</b>
Company name	
Respons. Department	
Person in charge	
Phone number	
Fax no	
E-mail address	

Operating area	Flow	Head	Impeller type
Operating data specification	0 m <sup>3</sup> /h	0 m	Impeller construction: Closed
Pump data	m <sup>3</sup> /h	m	Sense of rotation: Clockwise from the drive end
			Outlet width: DN40
	Flow	Head	Shaft power P2
	Min. Max. $\eta$ Max.	H(Q=0) $\eta$ Max.	P2(Q=0) Max. $\eta$ Max.
	m <sup>3</sup> /h m <sup>3</sup> /h m <sup>3</sup> /h	m m	kW kW kW
	20 55 44.9	52.8 41.4	7.46 7.26
			Speed: 1/min 2900
			Frequency: Hz 50 Hz

Performance data based to: Water, pure [100%] ; 20°C; 0.998kg/dm<sup>3</sup>; 1mm<sup>2</sup>/s

UNI EN ISO 9906:2012 - Grade 3B

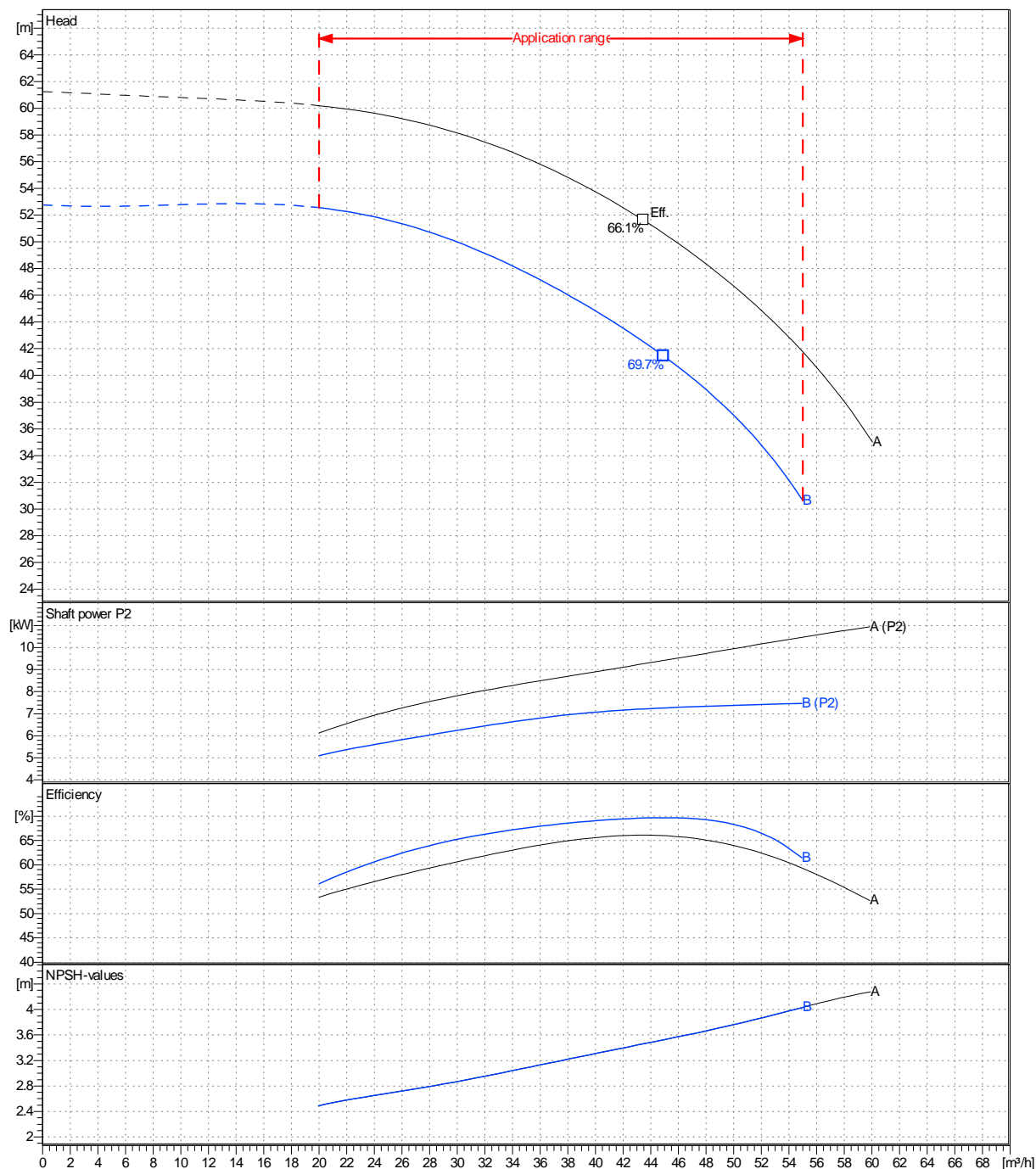

Project	Project ID	Created by	Created on	Last update
			<b>2022-03-09</b>	

Revision no

Pump dimensions

Connections

Suction side DN65 PN10/PN16	Discharge port DN40 PN10/PN16
-----------------------------------	-------------------------------------

Dimensions in mm

a  
b  
d  
f  
h1  
h2  
m1  
m2  
n1  
n2  
s  
w  
x1  
x2  
z1  
z2

100  
50  
12  
504  
160  
180  
100  
70  
265  
212  
14  
108  
320  
280  
261  
216

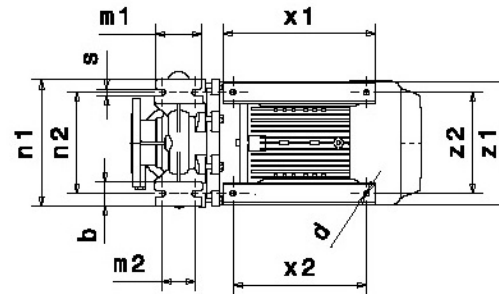
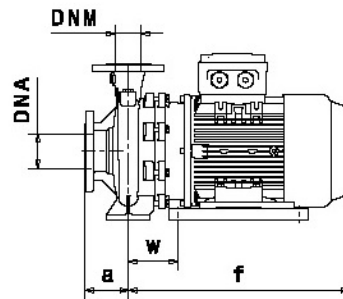
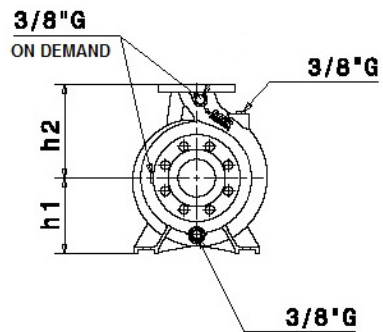

Disegni dimensionali e immagini non vincolanti. Saer si riserva il diritto di effettuare cambiamenti senza alcun preavviso.  
Dimensional drawing and picture are not binding. Saer reserves the right to make changes without prior notice.

Project

Project ID

Created by

Created on  
2022-03-09

Last update