

---

CATALOG | JULY 2023

## **Low voltage**

General performance cast iron motors  
for Europe

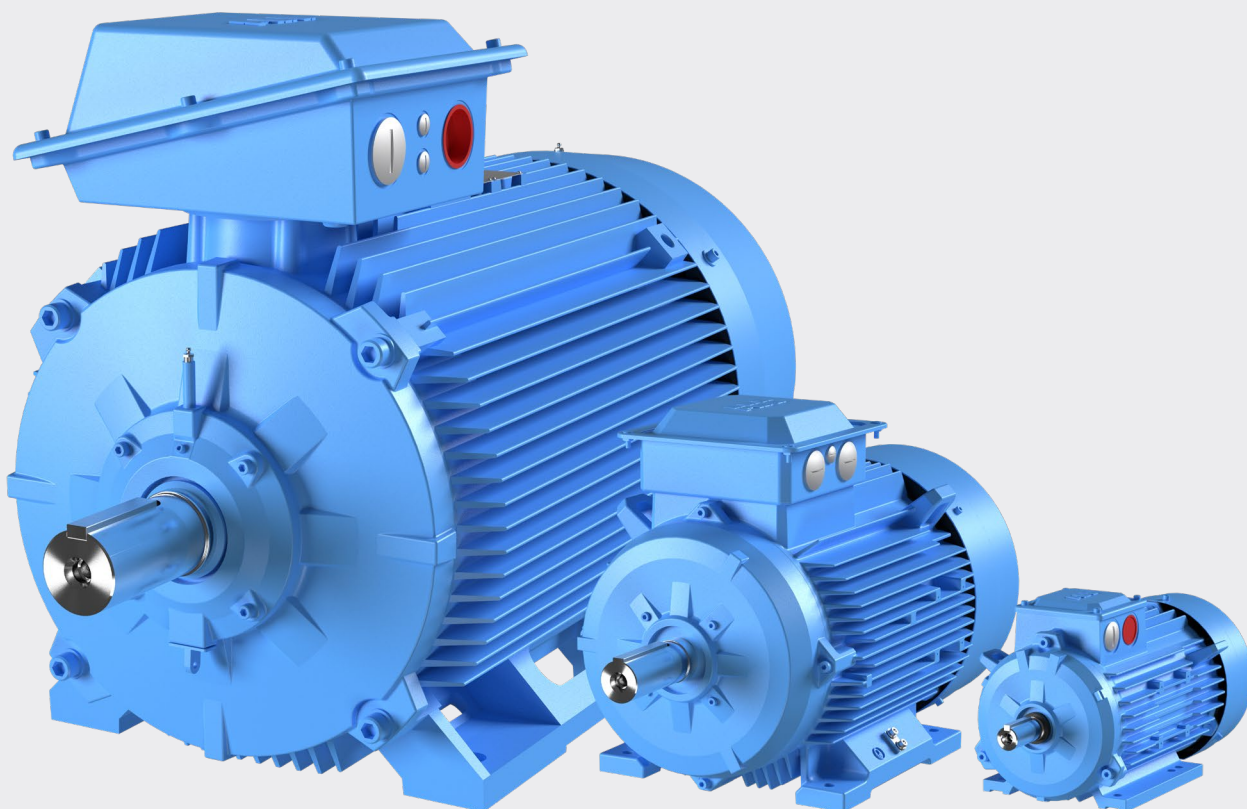

---

**With expertise, and a comprehensive portfolio of products and life-cycle services, we help value-minded industrial customers improve their energy efficiency and productivity.**

# Low voltage General performance cast iron motors

Sizes 71 to 355, 0.18 to 355 kW

<b>4</b>	<b>General information</b>
4	International motor efficiency standards and regulations
7	Mounting arrangements
8	Cooling
9	Degrees of protection: IP code/IK code
11	Voltage and frequency
<b>12</b>	<b>Cast iron motors</b>
12	Ordering information
13	Rating plates
14	Technical data IE4
17	Technical data IE3
20	Variant codes
23	Mechanical design
23	Bearings
32	Dimension drawings
34	Motors in brief
<b>40</b>	<b>Total product offering</b>
<b>41</b>	<b>ABB's portfolio of drives</b>

# International motor efficiency standards and regulations

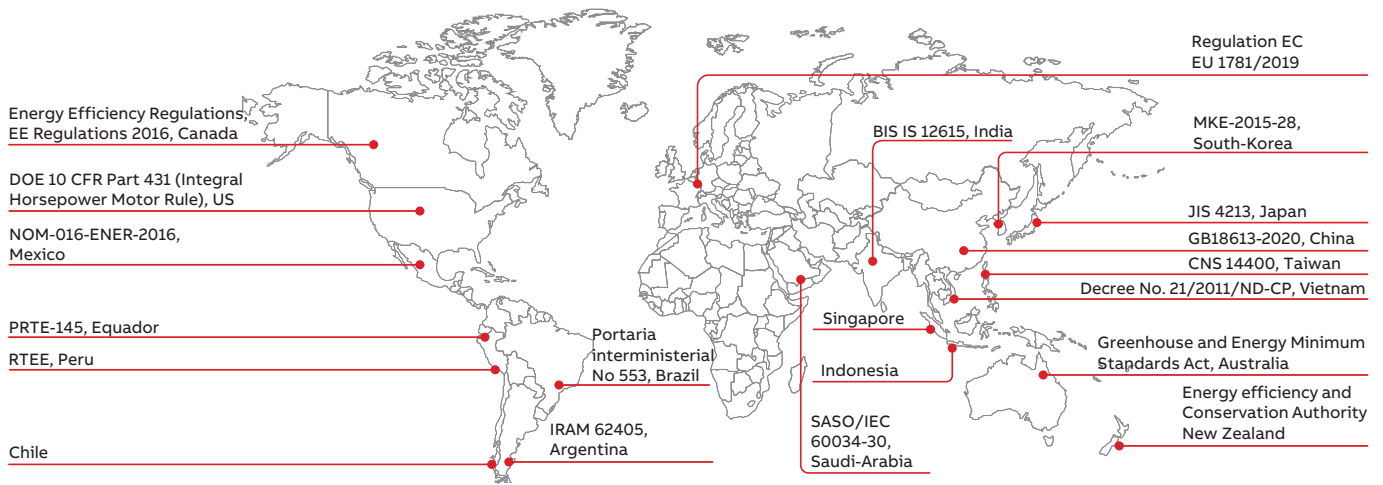

Since the validation of IEC 60034-30:2008 and its refined version IEC 60034-30-1:2014, a worldwide energy efficiency classification system has existed for low voltage three-phase asynchronous motors. These international standards have been created to enable and increase the level of harmonization in efficiency regulations around the world and to also cover motors for explosive atmospheres.

IEC 60034-30-1:2014 defines International Efficiency (IE) classes for single speed, three-phase, 50 Hz and 60 Hz induction motors. The efficiency levels defined in IEC 60034-30-1 are based on the test method specified in IEC 60034-2-1:2014. Both standards are part of an effort to unify motor testing procedures with CSA390-10 and IEEE 112 standards as well as efficiency and product labeling (IE) requirements to enable motor purchasers worldwide to easily recognize premium efficiency products.

To promote transparency in the market, IEC 60034-30-1 states that both the efficiency class and efficiency value must be shown on the motor rating plate and in product documentation. The documentation must clearly indicate the efficiency testing method used as different methods can produce differing results.

## Minimum energy performance standards

While the IEC as an international standardization organization sets guidelines for motor testing and efficiency classes, the organization does not regulate efficiency levels in countries. The biggest drivers for mandatory Minimum Energy Performance Standard (MEPS) levels for electric motors are global climate change, government targets to curb CO<sub>2</sub> emissions and rising electricity demand, especially in developing countries. The whole value chain, from manufacturer up to end user, must be aware of the legislation in order to meet local requirements, to save energy and reduce the carbon footprint.

Harmonized global standards and the increasing adoption of MEPS around the world are good news for all of us. However, it is important to remember that harmonization is an ongoing process. Even though MEPS are already in effect in several regions and countries, they are evolving and differ in terms of scope and requirements. At the same time, more countries are planning to adopt their own MEPS regulations. A view of existing and coming MEPS regulations in the world can be seen on the World map above.

To get the latest information please visit [new.abb.com/motors-generators/energy-efficiency](http://new.abb.com/motors-generators/energy-efficiency).

### IEC 60034-30-1:2014

This standard defines four International Efficiency (IE) classes for single speed electric motors that are rated according to IEC 60034-1 or IEC 60079-0 (explosive atmospheres) and designed for operation on sinusoidal voltage.

- IE4 = Super premium efficiency
- IE3 = Premium efficiency, identical to the table in 10CFR431 ('NEMA Premium') in the USA and CSA C390-10:2015 for 60 Hz
- IE2 = High efficiency
- IE1 = Standard efficiency

IEC 60034-30-1 covers the power range from 0.12 kW up to 1000 kW. Most of the different technical constructions of electric motors are covered as long as they are rated for direct on-line operation. The coverage of the standard includes:

- Single speed electric motors (single and three-phase), 50 and 60 Hz
- 2, 4, 6 and 8 poles
- Rated output  $P_N$  from 0.12 kW to 1000 kW
- Rated voltage  $U_N$  above 50 V up to 1 kV
- Motors capable of continuous operation at their rated power with a temperature rise within the specified insulation temperature class
- Motors, marked with any ambient temperature within the range of  $-20\text{ °C}$  to  $+60\text{ °C}$
- Motors, marked with an altitude up to 4000 m above sea level

By comparing IEC 60034-30-1 to CSA C390-10:2015 and "10CFR431 Subpart B – Electric motors", it can be seen that the efficiency limits and tables are well aligned and their major difference is in the scope of the output power where CSA and 10CFR431 have a maximum power of 500 hp. There are also some minor differences in the scope of excluded motors.

Note: CFR is Code of Federal Regulations.

The following motors are excluded from IEC 60034-30-1:

- Single-speed motors with 10 or more poles or multi-speed motors
- Motors completely integrated into a machine (for example pump, fan or compressor) that cannot be tested separately from the machine
- Brake motors, when the brake cannot be dismantled or separately fed

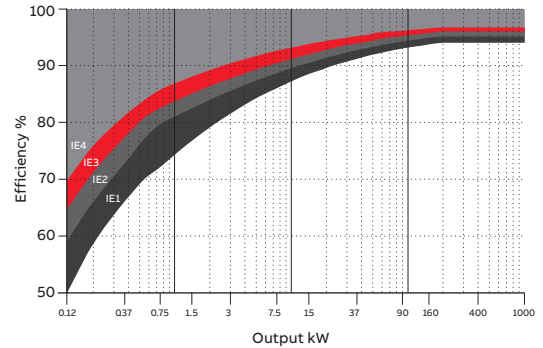

—  
01

### ABB and efficiency standards

ABB determines efficiency values according to IEC 60034-2-1 using the low uncertainty method (i.e. summation of losses), with additional load losses determined by the method of residual loss.

It is good to mention and emphasize that the IEC 60034-2-1 test method, which is known as an indirect method, is technically equivalent to the test methods in the standards CSA 390-10 and IEEE 112 Method B leading to the equivalent losses and thus efficiency values. Both test methods can be used by ABB and shall be used for both Canada and the US where IEC 60034-2-1 is not recognized yet.

As the world market leader, ABB offers the largest range of low voltage motors available. It has long advocated the need for efficiency in motors, and high efficiency products have formed the core of its portfolio for many years.

**Nominal efficiency limits defined in IEC 60034-30-1:2014 (reference values at 50 Hz, based on test methods specified in IEC 60034-2-1:2014).**

Output kW	IE1 Standard efficiency				IE2 High efficiency				IE3 Premium efficiency				IE4 Super Premium efficiency			
	2 pole	4 pole	6 pole	8 pole	2 pole	4 pole	6 pole	8 pole	2 pole	4 pole	6 pole	8 pole	2 pole	4 pole	6 pole	8 pole
0.12	45.0	50.0	38.3	31.0	53.6	59.1	50.6	39.8	60.8	64.8	57.7	50.7	66.5	69.8	64.9	62.3
0.18	52.8	57.0	45.5	38.0	60.4	64.7	56.6	45.9	65.9	69.9	63.9	58.7	70.8	74.7	70.1	67.2
0.20	54.6	58.5	47.6	39.7	61.9	65.9	58.2	47.4	67.2	71.1	65.4	60.6	71.9	75.8	71.4	68.4
0.25	58.2	61.5	52.1	43.4	64.8	68.5	61.6	50.6	69.7	73.5	68.6	64.1	74.3	77.9	74.1	70.8
0.37	63.9	66.0	59.7	49.7	69.5	72.7	67.6	56.1	73.8	77.3	73.5	69.3	78.1	81.1	78.0	74.3
0.40	64.9	66.8	61.1	50.9	70.4	73.5	68.8	57.2	74.6	78.0	74.4	70.1	78.9	81.7	78.7	74.9
0.55	69.0	70.0	65.8	56.1	74.1	77.1	73.1	61.7	77.8	80.8	77.2	73.0	81.5	83.9	80.9	77.0
0.75	72.1	72.1	70.0	61.2	77.4	79.6	75.9	66.2	80.7	82.5	78.9	75.0	83.5	85.7	82.7	78.4
1.1	75.0	75.0	72.9	66.5	79.6	81.4	78.1	70.8	82.7	84.1	81.0	77.7	85.2	87.2	84.5	80.8
1.5	77.2	77.2	75.2	70.2	81.3	82.8	79.8	74.1	84.2	85.3	82.5	79.7	86.5	88.2	85.9	82.6
2.2	79.7	79.7	77.7	74.2	83.2	84.3	81.8	77.6	85.9	86.7	84.3	81.9	88.0	89.5	87.4	84.5
3	81.5	81.5	79.7	77.0	84.6	85.5	83.3	80.0	87.1	87.7	85.6	83.5	89.1	90.4	88.6	85.9
4	83.1	83.1	81.4	79.2	85.8	86.6	84.6	81.9	88.1	88.6	86.8	84.8	90.0	91.1	89.5	87.1
5.5	84.7	84.7	83.1	81.4	87.0	87.7	86.0	83.8	89.2	89.6	88.0	86.2	90.9	91.9	90.5	88.3
7.5	86.0	86.0	84.7	83.1	88.1	88.7	87.2	85.3	90.1	90.4	89.1	87.3	91.7	92.6	91.3	89.3
11	87.6	87.6	86.4	85.0	89.4	89.8	88.7	86.9	91.2	91.4	90.3	88.6	92.6	93.3	92.3	90.4
15	88.7	88.7	87.7	86.2	90.3	90.6	89.7	88.0	91.9	92.1	91.2	89.6	93.3	93.9	92.9	91.2
18.5	89.3	89.3	88.6	86.9	90.9	91.2	90.4	88.6	92.5	92.6	91.7	90.1	93.7	94.2	93.4	91.7
22	89.9	89.9	89.2	87.4	91.3	91.6	90.9	89.1	92.7	93.0	92.2	90.6	94.0	94.5	93.7	92.1
30	90.7	90.7	90.2	88.3	92.0	92.3	91.7	89.8	93.3	93.6	92.9	91.3	94.5	94.9	94.2	92.7
37	91.2	91.2	90.8	88.8	92.5	92.7	92.2	90.3	93.7	93.9	93.3	91.8	94.8	95.2	94.5	93.1
45	91.7	91.7	91.4	89.2	92.9	93.1	92.7	90.7	94.0	94.2	93.7	92.2	95.0	95.4	94.8	93.4
55	92.1	92.1	91.9	89.7	93.2	93.5	93.1	91.0	94.3	94.6	94.1	92.5	95.3	95.7	95.1	93.7
75	92.7	92.7	92.6	90.3	93.8	94.0	93.7	91.6	94.7	95.0	94.6	93.1	95.6	96.0	95.4	94.2
90	93.0	93.0	92.9	90.7	94.1	94.2	94.0	91.9	95.0	95.2	94.9	93.4	95.8	96.1	95.6	94.4
110	93.3	93.3	93.3	91.1	94.3	94.5	94.3	92.3	95.2	95.4	95.1	93.7	96.0	96.3	95.8	94.7
132	93.5	93.5	93.5	91.5	94.6	94.7	94.6	92.6	95.4	95.6	95.4	94.0	96.2	96.4	96.0	94.9
160	93.8	93.8	93.8	91.9	94.8	94.9	94.8	93.0	95.6	95.8	95.6	94.3	96.3	96.6	96.2	95.1
200	94.0	94.0	94.0	92.5	95.0	95.1	95.0	93.5	95.8	96.0	95.8	94.6	96.5	96.7	96.3	95.4
250	94.0	94.0	94.0	92.5	95.0	95.1	95.0	93.5	95.8	96.0	95.8	94.6	96.5	96.7	96.5	95.4
315	94.0	94.0	94.0	92.5	95.0	95.1	95.0	93.5	95.8	96.0	95.8	94.6	96.5	96.7	96.6	95.4
355	94.0	94.0	94.0	92.5	95.0	95.1	95.0	93.5	95.8	96.0	95.8	94.6	96.5	96.7	96.6	95.4
400	94.0	94.0	94.0	92.5	95.0	95.1	95.0	93.5	95.8	96.0	95.8	94.6	96.5	96.7	96.6	95.4
450	94.0	94.0	94.0	92.5	95.0	95.1	95.0	93.5	95.8	96.0	95.8	94.6	96.5	96.7	96.6	95.4
500-1000	94.0	94.0	94.0	92.5	95.0	95.1	95.0	93.5	95.8	96.0	95.8	94.6	96.5	96.7	96.6	95.4

# Mounting arrangements

## Foot-mounted motor

### Code I / code II

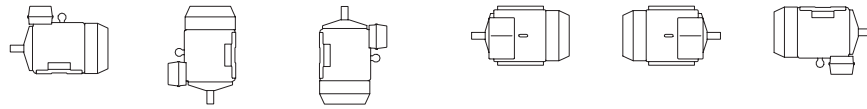

IM B3	IM V5	IM V6	IM B6	IM B7	IM B8
IM 1001	IM 1011	IM 1031	IM 1051	IM 1061	IM 1071

### Product code pos. 12

A: foot-mounted, term. box top  
R: foot-mounted, term. box RHS  
L: foot-mounted, term. box LHS

## Flange-mounted motor, large flange

### Code I / code II

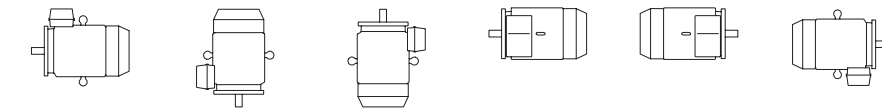

IM B5	IM V1	IM V3	*)	*)	*)
IM 3001	IM 3011	IM 3031	IM 3051	IM 3061	IM 3071

### Product code pos. 12

B: flange mounted, large flange

## Flange-mounted motor, small flange

### Code I / code II

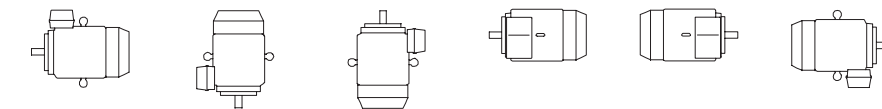

IM B14	IM V18	IM V19	*)	*)	*)
IM 3601	IM 3611	IM 3631	IM 3651	IM 3661	IM 3671

### Product code pos. 12

C: flange mounted, small flange

## Foot- and flange-mounted motor with feet, large flange

### Code I / code II

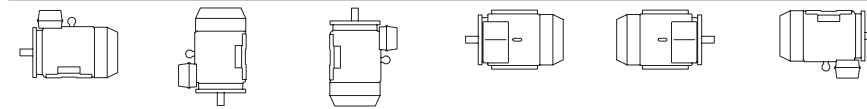

IM B35	IM V15	IM V35	*)	*)	*)
IM 2001	IM 2011	IM 2031	IM 2051	IM 2061	IM 2071

### Product code pos. 12

H: foot/flange-mounted, term. box top  
S: foot/flange-mounted, term. box RHS  
T: foot/flange-mounted, term. box LHS

## Foot- and flange-mounted motor with feet, small flange

### Code I / code II

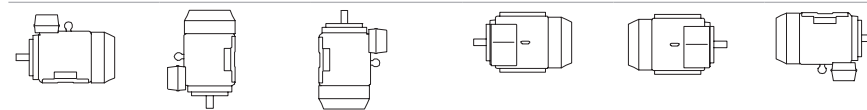

IM B34	IM V17	IM 2131	IM 2151	IM 2161	IM 2171
IM 2101	IM 2111	IM 2131	IM 2151	IM 2161	IM 2171

### Product code pos. 12

J: foot/flange-mounted, small flange

## Foot-mounted motor, shaft with free extensions

### Code I / code II

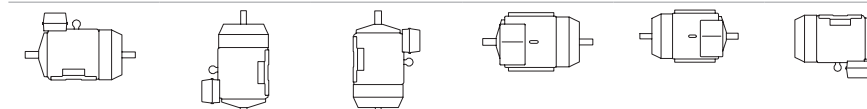

IM 1002	IM 1012	IM 1032	IM 1052	IM 1062	IM 1072
---------	---------	---------	---------	---------	---------

### Product code pos. 12

\*) Not stated in IEC 60034-7.

Note: If the motor is mounted shaft upwards, take measures to prevent water or any other liquid from running down the shaft into the motor.

# General information

## Cooling

Designation system concerning methods of cooling refers to standard IEC 60034-6.

### Explanation of the product code

International Cooling	Circuit arrangement	Primary coolant	Method of movement of primary coolant	Secondary coolant	Method of movement of secondary coolant
IC	4	(A)	1	(A)	6
	1	2	3	4	5

#### Position 1

0:	Free circulation (open circuit)
4:	Free circulation (open circuit)

#### Position 2

A:	For air (omitted for simplified designation)
----	--

#### Position 3

0:	Free convection
1:	Self-circulation
6:	Machine-mounted independent component

#### Position 4

A:	For air (omitted for simplified designation)
W:	For water

#### Position 5

0:	Free convection
1:	Self-circulation
6:	Machine-mounted independent component
8:	Relative displacement



# General information

## Degrees of protection: IP code/IK code

Classification of degrees of protection provided by enclosures of rotating machines are refers to:

- Standard IEC 60034-5 or EN 60529 for IP code
- Standard EN 50102 for IK code

### IP protection

Protection of persons against getting in contact with (or approaching) live parts and against contact with moving parts inside the enclosure. Also protection of the machine against ingress of solid foreign objects. Protection of machines against the harmful effects due to the ingress of water.

#### Explanation of the IP code

Ingress protection	Degree of protection to persons and to parts of the motors inside the enclosure	Degree of protection provided by the enclosure with respect to harmful effects due to ingress of water
<b>IP</b>	<b>5</b>	<b>5</b>
	1	2

#### Position 1

2:	Motors protected against solid objects greater than 12 mm
4:	Motors protected against solid objects greater than 1 mm
5:	Dust-protected motors
6:	Dust-tight motors

#### Position 2

3:	Motors protected against spraying water
4:	Motors protected against splashing water
5:	Motors protected against water jets
6:	Motors protected against heavy seas

### IK code

Classification of degrees of protection provided by enclosure for motors against external mechanical impacts.

#### Explanation of the IK code

International mechanical protection	Characteristic group
<b>IK</b>	<b>08</b>
	1

#### Position 1

##### Relation between IK code and impact energy:

IK code	Impact energy/Joule
0:	Not protected according to EN 50102
01:	0.15
02:	0.2
03:	0.35
04:	0.5
05:	0.7
06:	1
07:	2
08:	5 (ABB Standard)
09:	10
10:	20

# Insulation

—  
01 Safety margins per thermal class

ABB uses class F insulation, which, with temperature rise B, is the most common requirement among industry today.

The use of class F insulation with class B temperature rise gives ABB products a 25 °C safety margin. This can be used to increase the loading for limited periods, to operate at higher ambient temperatures or altitudes, or with greater voltage and frequency tolerances. It can also be used to extend insulation. For instance, a 10 K temperature reduction will extend the insulation life.

## Thermal class 130 (B)

- Nominal ambient temperature 40 °C
- Max permissible temperature rise 80 K
- Hot spot temperature margin 10 K

## Thermal class 155 (F)

- Nominal ambient temperature 40 °C
- Max permissible temperature rise 105 K
- Hot spot temperature margin 10 K

## Thermal class 180 (H)

- Nominal ambient temperature 40 °C
- Max permissible temperature rise 125 K
- Hot spot temperature margin 10 K

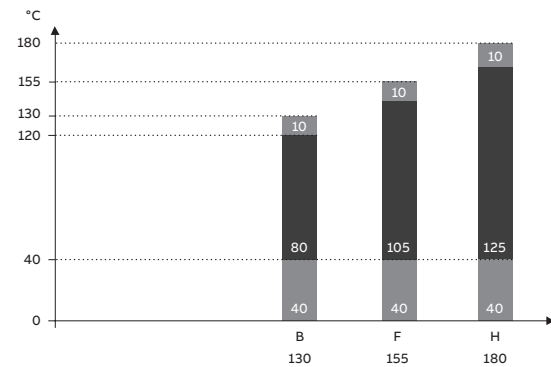

—  
01

# General information

## Voltage and frequency

—  
01 Voltage and frequency  
deviation in zones A  
and B

The impact on temperature rise caused by voltage and frequency fluctuation is defined in IEC 60034-1. The standard divides the combinations into two zones, A and B. Zone A is the combination of voltage deviation of  $\pm 5\%$  and frequency deviation of  $\pm 2\%$ . Zone B is the combination of voltage deviation of  $\pm 10\%$  and frequency deviation of  $\pm 3\%$ . This is illustrated in figure below.

Motors are capable of supplying the rated torque in both zones A and B, but the temperature rise will be higher than at rated voltage and frequency. Motors can be run in zone B only for a short period of time.

### Key

X axis	frequency p.u.
Y axis	voltage p.u.
1	zone A
2	zone B (outside zone A)
3	rating point

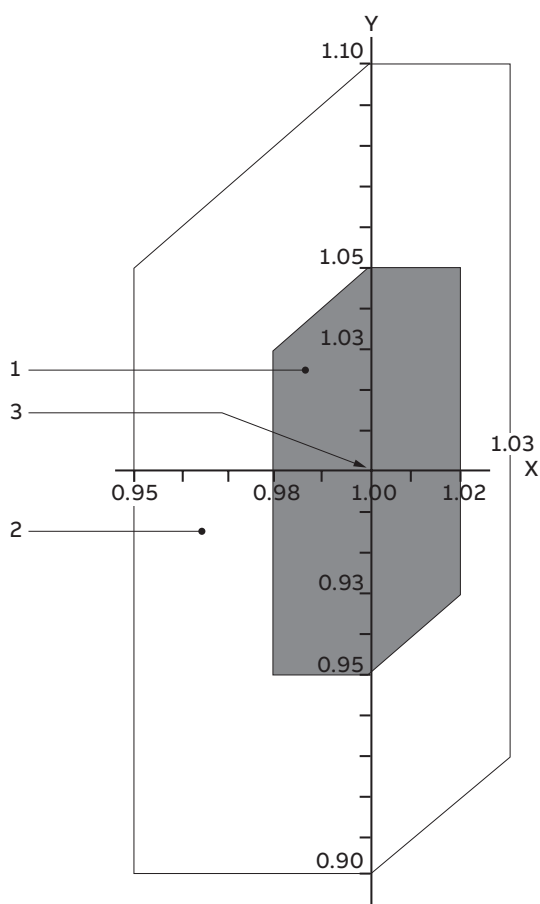

—  
01

# Ordering information

## Explanation of the product code

Motor type	Motor size	Product code	Mounting arrangement code, Voltage and frequency code, Generation code	Variant codes
M2BAX	112MA	3GBA 112 310	- ADD	002, etc.
		1 2 3 4 5 6 7 8 9 10 11 12 13 14		

### Positions 1 to 4

3GBA: Totally enclosed fan cooled squirrel cage motor with cast iron frame

### Positions 5 and 6

IEC size

07:	71
08:	80
09:	90
10:	100
11:	112
13:	132
16:	160
18:	180
20:	200
22:	225
25:	250
28:	280
31:	315
35:	355

### Position 7

Speed (Pole pairs)

1:	2 poles
2:	4 poles
3:	6 poles

### Positions 8 to 10

Running number

### Position 11

-(dash)

### Position 12 (marked with black dot in data tables)

Mounting arrangement

A:	Foot-mounted, top-mounted terminal box
B:	Flange-mounted, large flange

### Position 13 (marked with black dot in data tables)

Voltage and frequency

Single-speed motors

D:	400 VΔ, 690 VY, 380 VΔ, 660 VY, 50 Hz
S:	230 VΔ, 400 VY, 220 VΔ, 380 VY, 50 Hz

### Position 14

A, B, C... = Generation code followed by variant codes

Efficiency values are given according to IEC 60034- 2-1; 2014.

For detailed dimension drawings please see our web-pages [new.abb.com/motors-generators](http://new.abb.com/motors-generators) or contact ABB.

# Rating plates

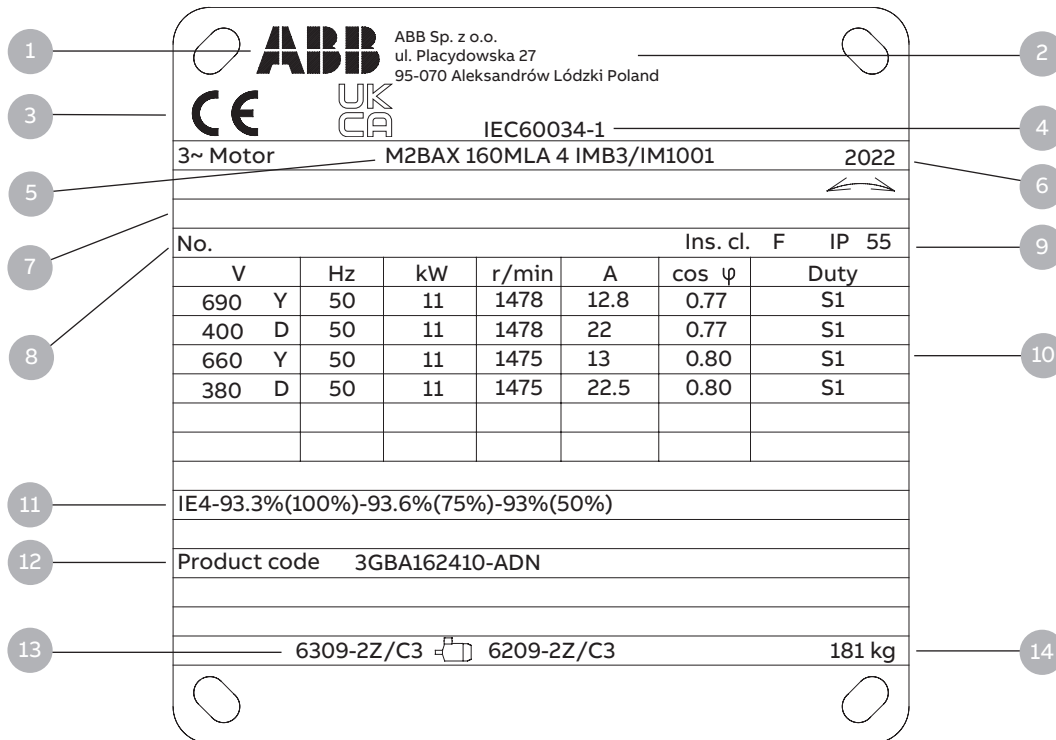

- 1 ABB Logo
- 2 Manufacturing place
- 3 CE mark for fulfilling European Directives and Regulations
- 4 Manufacturing standard
- 5 Product description
- 6 Manufacturing year
- 7 Factory order reference number
- 8 Serial number
- 9 Insulation class, IP protection class
- 10 Voltage, Frequency, output, speed, current, power factory, duty
- 11 Efficiency class and efficiency 50 Hz at 100%, 75%, 50%; 60 Hz at 100%
- 12 Product code
- 13 Bearing type
- 14 Weight

# Technical data

## IE4 General performance cast iron motors

IP 55 - IC 411 - Insulation class F, temperature rise class B

IE4 efficiency class according to IEC 60034-30-1; 2014

Output kW	Motor type	Product code	Speed r/min	Efficiency IEC 60034-30-1: 2014			Power factor Cosφ	Current			Torque			Moment of inertia J = 1/4 GD <sub>2</sub> kgm <sub>2</sub>	Weight kg	Sound pressure Level L <sub>PA</sub> dB
				Full load 100%	3/4 load 75%	1/2 load 50%		I <sub>n</sub> A	I <sub>s</sub> /I <sub>n</sub>	T <sub>N</sub> Nm	T <sub>r</sub> /T <sub>N</sub>	T <sub>b</sub> /T <sub>N</sub>				
<b>3000 r/min = 2 poles</b>				<b>400 V 50 Hz</b>				<b>CENELEC-design</b>								
0.75	M2BAX 80MA 2	3GBA081310-**-N	2887	83.5	83.9	82.3	0.83	1.56	7.8	2.5	3.6	3.9	0.00108	18	59	
1.1	M2BAX 80MLA 2	3GBA081410-**-N	2884	85.2	86.1	85.2	0.84	2.2	8.0	3.7	3.8	4.0	0.00144	22	59	
1.5	M2BAX 90SA 2	3GBA091110-**-N	2915	86.5	87.4	86.6	0.87	2.9	8.6	4.9	3.3	4.1	0.0027	26	59	
2.2	M2BAX 90SLA 2	3GBA091010-**-N	2925	88.0	88.8	88.2	0.88	4.1	9.6	7.2	3.6	4.7	0.0038	34	60	
3	M2BAX 100LKA 2	3GBA101810-**-N	2892	89.1	90.7	91.1	0.89	5.5	8.2	10.1	3.0	3.8	0.00641	50	59	
4	M2BAX 112MLA 2	3GBA111410-**-N	2893	90.0	88.2	88.6	0.88	7.3	8.3	13.2	2.8	3.6	0.00828	56	62	
5.5	M2BAX 132SA 2	3GBA131110-**-N	2910	90.9	91.4	91.2	0.86	10.1	8.3	18.0	2.4	3.6	0.014	76	65	
7.5	M2BAX 132SMA 2	3GBA131210-**-N	2910	91.7	92.6	92.7	0.89	13.3	8.2	24.6	2.4	3.5	0.0166	88	65	
11	M2BAX 160MLA 2	3GBA161410-**-N	2953	92.6	92.9	92.4	0.88	19.5	8.3	35.6	3.3	4.1	0.0514	143	69	
15	M2BAX 160MLB 2	3GBA161420-**-N	2951	93.3	93.5	92.9	0.89	26.2	10.2	48.5	3.9	4.5	0.063	162	70	
18.5	M2BAX 160MLC 2	3GBA161430-**-N	2942	93.7	94.1	94.0	0.90	31.8	9.6	60.1	3.7	4.1	0.076	175	70	
22	M2BAX 180MLA 2	3GBA181410-**-N	2959	94.0	94.3	93.9	0.88	38.3	8.9	71.0	3.5	4.1	0.126	231	74	
30	M2BAX 200MLA 2	3GBA201410-**-N	2961	94.5	94.7	94.4	0.88	52.1	8.8	96.8	3.6	3.7	0.196	283	79	
37	M2BAX 200MLB 2	3GBA201420-**-N	2962	94.8	95.1	94.8	0.87	64.8	9.2	119	3.2	3.7	0.217	288	78	
45	M2BAX 225SMA 2	3GBA221210-**-N	2976	95.0	95.1	94.5	0.88	78.0	9.5	144	4.1	3.5	0.295	372	81	
55	M2BAX 250SMA 2	3GBA251210-**-N	2974	95.3	95.5	95.0	0.90	93.0	8.4	176.6	3.3	3.6	0.547	459	79	
75	M2BAX 280SMA 2	3GBA281210-**-N	2980	95.6	95.6	94.9	0.87	130	7.3	240	2.5	2.9	0.9	709	77	
90	M2BAX 280SMB 2	3GBA281220-**-N	2981	95.8	95.6	95.0	0.88	154	8.0	288	3.0	3.1	1.15	782	77	
110	M2BAX 315SMA 2	3GBA311210-**-N	2982	96.0	96.0	95.3	0.87	190	6.7	352	1.9	2.6	1.4	1028	77	
132	M2BAX 315SMB 2	3GBA311220-**-N	2986	96.2	96.3	95.9	0.87	228	7.9	422	2.4	3.0	1.7	1096	77	
160	M2BAX 315MLA 2	3GBA311410-**-N	2983	96.3	96.5	96.3	0.89	269	7.3	512	2.2	2.7	2.1	1319	77	
200	M2BAX 315MLB 2	3GBA311420-**-N	2983	96.5	96.9	96.8	0.89	336	6.8	640	1.9	2.6	2.2	1358	77	
250	M2BAX 355SMA 2	3GBA351210-**-N	2983	96.5	96.6	96.2	0.89	420	7.6	800	2.2	2.0	3.4	1590	83	
315	M2BAX 355SMB 2	3GBA351220-**-N	2984	96.5	96.5	95.9	0.88	535	7.8	1008	2.3	2.8	3.6	1668	83	
355	M2BAX 355MLA 2	3GBA351410-**-N	2981	96.5	96.8	96.4	0.89	597	7.5	1137	2.3	2.6	4.1	1845	83	

# Technical data

## IE4 General performance cast iron motors

IP 55 - IC 411 - Insulation class F, temperature rise class B  
General efficiency class according to IEC 60034-30-1; 2014

Output kW	Motor type	Product code	Speed r/min	Efficiency IEC 60034-30-1: 2014			Power factor Cosφ	Current		Torque			Moment of inertia J = 1/4 GD <sub>2</sub> kgm <sub>2</sub>	Weight kg	Sound pressure Level L <sub>PA</sub> dB
				Full load 100%	3/4 load 75%	1/2 load 50%		I <sub>n</sub> A	I <sub>s</sub> /I <sub>n</sub>	T <sub>N</sub> Nm	T <sub>r</sub> /T <sub>N</sub>	T <sub>b</sub> /T <sub>N</sub>			
1500 r/min = 4 poles				400 V 50 Hz				CENELEC-design							
0.55	M2BAX 80MLA 4	3GBA082410-**-N	1449	83.9	84.3	82.6	0.81	1.17	7.0	3.6	3.2	3.8	0.0028	22	47
2.2	M2BAX 100LKA 4	3GBA102810-**-N	1465	89.5	90.9	89.5	0.80	4.4	8.2	14.4	2.2	3.2	0.015	46	53
3	M2BAX 100LKB 4	3GBA102820-**-N	1464	90.4	91.1	90.7	0.81	5.9	8.3	19.8	2.5	3.5	0.021	52	54
4	M2BAX 112MLA 4	3GBA112410-**-N	1461	91.1	91.7	91.3	0.79	8.0	8.5	26.4	2.6	3.8	0.0189	62	56
5.5	M2BAX 132SA 4	3GBA132110-**-N	1475	91.9	91.9	91.0	0.79	10,9	8.4	35.6	3.0	3.8	0.042	83	62
7.5	M2BAX 132SMA 4	3GBA132210-**-N	1473	92.6	92.9	92.1	0.80	14,7	8.4	48.6	2.5	3.7	0.057	102	64
11	M2BAX 160MLA 4	3GBA162410-**-N	1478	93.3	93.6	93.0	0.77	22,0	8.2	71.1	3.0	3.9	0.123	181	59
15	M2BAX 160MLB 4	3GBA162420-**-N	1476	93.9	94.1	93.8	0.74	31,0	8.9	97.1	3.7	4.1	0.127	178	59
18.5	M2BAX 180MLA 4	3GBA182410-**-N	1484	94.2	94.3	93.5	0.81	35,0	9.2	119	3.5	4.2	0.191	205	65
22	M2BAX 180MLB 4	3GBA182420-**-N	1484	94.5	94.6	94.0	0.82	41,0	9.2	142	3.5	4.1	0.22	220	65
30	M2BAX 200MLA 4	3GBA202410-**-N	1488	94.9	94.9	94.1	0.75	60,8	9.3	193	4.3	4.2	0.369	268	64
37	M2BAX 225SMA 4	3GBA222210-**-N	1483	95.2	95.5	95.3	0.83	67,3	9.0	239	3.8	3.6	0.54	380	64
45	M2BAX 225SMB 4	3GBA222220-**-N	1481	95.4	95.7	95.6	0.82	82,7	8.7	290	3.8	3.5	0.54	380	64
55	M2BAX 250SMA 4	3GBA252210-**-N	1485	95.7	95.8	95.3	0.85	97,3	9.9	354	4.7	3.8	0.939	483	69
75	M2BAX 280SMA 4	3GBA282210-**-N	1487	96.0	96.4	96.1	0.86	131	7.8	481	2.8	2.9	1.85	787	72
90	M2BAX 280SMB 4	3GBA282220-**-N	1486	96.1	96.3	96.1	0.84	161	8.3	580	3.2	3.4	1.88	811	63
110	M2BAX 315SMA 4	3GBA312210-**-N	1491	96.3	96.4	96.0	0.85	194	7.9	705	2.4	3.1	2.64	905	66
132	M2BAX 315SMB 4	3GBA312220-**-N	1489	96.4	96.6	96.1	0.84	235	7.9	846	2.6	3.2	3.02	961	68
160	M2BAX 315MLA 4	3GBA312410-**-N	1490	96.6	96.8	96.5	0.86	278	7.9	1026	2.7	3.1	3.63	1106	68
200	M2BAX 315LKA 4	3GBA312810-**-N	1490	96.7	96.9	96.7	0.86	347	7.8	1282	2.4	3.6	4.74	1332	66
250	M2BAX 355SMA 4	3GBA352210-**-N	1490	96.7	96.9	96.6	0.85	439	7.8	1601	2.5	2.9	6.49	1646	74
315	M2BAX 355SMB 4	3GBA352220-**-N	1490	96.7	96.9	96.8	0.83	566	7.4	2018	2.8	2.9	7.2	1738	74
355	M2BAX 355MLA 4	3GBA352410-**-N	1491	96.7	96.9	96.6	0.85	623	7.4	2271	2.7	4.1	8.4	2001	77

# Technical data

## IE4 General performance cast iron motors

IP 55 - IC 411 - Insulation class F, temperature rise class B  
General efficiency class according to IEC 60034-30-1; 2014

Output kW	Motor type	Product code	Speed r/min	Efficiency IEC 60034-30-1: 2014			Power factor Cosφ	Current			Torque			Moment of inertia J = 1/4 GD <sub>2</sub> kgm <sub>2</sub>	Weight kg	Sound pressure Level L <sub>PA</sub> dB
				Full load 100%	3/4 load 75%	1/2 load 50%		I <sub>n</sub> A	I <sub>s</sub> /I <sub>n</sub>	T <sub>N</sub> Nm	T <sub>r</sub> /T <sub>N</sub>	T <sub>b</sub> /T <sub>N</sub>				
<b>1000 r/min = 6 poles</b>				<b>400 V 50 Hz</b>				<b>CENELEC-design</b>								
0.37	M2BAX 80MLA 6	3GBA083410-**-N	956	78.0	77.8	74.4	0.72	0.95	4.8	3.7	2.3	3.0	0.0038	22	46	
0.55	M2BAX 80MLB 6	3GBA083420-**-N	957	80.9	80.5	77.3	0.69	1.42	5.1	5.5	2.7	3.4	0.0044	24	47	
0.75	M2BAX 90SLA 6	3GBA093010-**-N	948	82.7	82.7	81.3	0.72	1.82	4.9	7.6	2.7	3.1	0.0061	32	55	
1.5	M2BAX 100LKA 6	3GBA103810-**-N	969	85.9	85.8	84.2	0.73	3.5	7.3	14.9	2.5	3.6	0.0121	46	47	
2.2	M2BAX 112MLA 6	3GBA113410-**-N	980	87.4	88.1	87.1	0.68	5.4	7.1	21.4	2.3	3.3	0.022	56	46	
3	M2BAX 132SA 6	3GBA133110-**-N	983	88.6	88.9	87.4	0.68	7.2	7.1	29.1	2.2	3.4	0.042	73	57	
4	M2BAX 132SMA 6	3GBA133210-**-N	983	89.5	89.9	88.6	0.68	9.5	7.4	38.9	2.4	3.5	0.053	86	57	
5.5	M2BAX 132SMB 6	3GBA133220-**-N	981	90.5	91.1	90.5	0.71	12.4	7.3	53.5	2.3	3.3	0.068	99	57	
7.5	M2BAX 160MLA 6	3GBA163410-**-N	984	91.3	91.0	89.4	0.75	15.8	7.1	72.8	1.8	3.6	0.133	170	59	
11	M2BAX 160MLB 6	3GBA163420-**-N	980	92.3	92.3	91.7	0.76	22.8	7.3	109	1.9	3.4	0.133	190	59	
15	M2BAX 180MLA 6	3GBA183410-**-N	985	92.9	92.8	91.8	0.71	32.8	7.2	147	2.7	3.7	0.229	227	59	
18.5	M2BAX 200MLA 6	3GBA203410-**-N	990	93.4	93.8	93.4	0.78	36.6	7.6	178	2.9	3.7	0.448	264	62	
22	M2BAX 200MLB 6	3GBA203420-**-N	989	93.7	93.8	93.3	0.79	42.9	7.8	212	3.0	3.8	0.531	291	63	
30	M2BAX 225SMA 6	3GBA223210-**-N	988	94.2	94.5	94.2	0.80	57.6	8.0	290	3.6	3.7	0.813	372	63	
37	M2BAX 250SMA 6	3GBA253210-**-N	991	94.5	94.9	94.6	0.81	69.6	8.1	356	3.4	3.3	1.5	478	62	
45	M2BAX 280SMA 6	3GBA283210-**-N	990	94.8	95.1	94.7	0.84	81.3	8.2	434	3.1	2.8	2.04	634	63	
55	M2BAX 280SMB 6	3GBA283220-**-N	990	95.1	95.4	95.1	0.84	99.9	7.1	530	2.9	2.7	2.57	728	63	
75	M2BAX 315SMA 6	3GBA313210-**-N	994	95.4	95.7	95.0	0.82	138	7.8	721	2.7	3.2	4.76	926	67	
90	M2BAX 315SMB 6	3GBA313220-**-N	993	95.6	95.8	95.3	0.80	170	7.9	865	2.6	3.1	5.19	933	67	
110	M2BAX 315MLA 6	3GBA313410-**-N	993	95.8	96.1	95.8	0.82	202	7.7	1058	2.3	2.7	6.16	1106	68	
132	M2BAX 315LKA 6	3GBA313810-**-N	993	96.0	96.2	96.1	0.83	239	6.8	1270	2.5	3.2	7.16	1288	62	
160	M2BAX 355SMA 6	3GBA353210-**-N	994	96.2	96.2	96.1	0.82	292	7.3	1537	2.5	3.1	9.5	1587	73	
200	M2BAX 355SMB 6	3GBA353220-**-N	994	96.3	96.5	96.0	0.81	370	8.1	1921	2.6	3.2	11.3	1734	73	
250	M2BAX 355MLA 6	3GBA353410-**-N	994	96.5	96.8	96.7	0.83	451	6.2	2403	2.0	3.5	13.2	1984	70	



# Technical data

## IE3 General performance cast iron motors

IP 55 - IC 411 - Insulation class F, temperature rise class B  
IE3 efficiency class according to IEC 60034-30-1; 2014

Output kW	Motor type	Product code	Speed r/min	Efficiency IEC 60034-30-1: 2014			Power factor Cos	Current			Torque			Moment of inertia J = 1/4 GD- 2 kgm <sub>2</sub>	Weight kg	Sound pressure Level L <sub>PA</sub> dB
				Full load 100%	3/4 load 75%	1/2 load 50%		I <sub>n</sub> A	I <sub>s</sub> /I <sub>n</sub>	T <sub>N</sub> Nm	T <sub>r</sub> /T <sub>N</sub>	T <sub>b</sub> /T <sub>N</sub>				
3000 r/min = 2 poles				400 V 50 Hz				CENELEC-design								
0.37	M2BAX 71MC 2	3GBA071330-..D	2819	76.5	76.0	73.4	0.80	0.86	6.6	1.3	2.7	3.2	0.00035	10	50	
0.55	M2BAX 71MB 2	3GBA071320-..D	2816	78.4	78.1	75.9	0.80	1.27	6.1	1.9	2.7	3.2	0.00040	10	49	
0.75	M2BAX 80MC 2	3GBA081330-..D	2891	80.7	81.0	78.9	0.80	1.66	7.5	2.5	2.9	3.7	0.00081	16	58	
1.1	M2BAX 80MD 2	3GBA081340-..D	2860	82.7	83.3	82.6	0.84	2.29	7.6	3.7	3.2	3.6	0.0010	17	60	
1.5	M2BAX 90SB 2	3GBA091120-..D	2899	84.2	84.4	83.4	0.86	2.99	8.3	4.9	2.8	3.7	0.0023	23	59	
2.2	M2BAX 90SLA 2	3GBA091010-..D	2903	85.9	86.1	85.3	0.86	4.30	9.1	7.2	3.3	4.1	0.0030	26	67	
3	M2BAX 100LKA 2	3GBA101810-..D	2904	87.1	88.1	88.3	0.91	5.46	9.3	9.9	2.6	3.4	0.0069	42	62	
4	M2BAX 112MB 2	3GBA111320-..D	2909	88.1	88.6	88.1	0.92	7.12	9.6	13.1	3.5	4.3	0.0071	42	64	
5.5	M2BAX 132SMA 2	3GBA131210-..D	2934	89.2	89.8	89.0	0.82	10.6	8.9	17.9	2.4	4.1	0.014	64	65	
7.5	M2BAX 132SMB 2	3GBA131220-..D	2921	90.1	91.0	90.9	0.84	14.0	9.0	24.5	2.6	4.0	0.017	60	65	
11	M2BAX 160MLA 2	3GBA161410-..F	2943	91.2	92.0	91.6	0.91	19.1	7.2	35.6	2.6	3.6	0.057	121	69	
15	M2BAX 160MLB 2	3GBA161420-..F	2939	91.9	92.1	91.9	0.87	27.1	7.8	48.7	2.8	3.4	0.063	128	69	
18.5	M2BAX 160MLC 2	3GBA161430-..F	2949	92.4	93.0	92.6	0.90	32.0	9.0	59.8	3.3	3.9	0.076	145	73	
22	M2BAX 180MLA 2	3GBA181410-..F	2946	92.7	92.8	92.3	0.87	39.4	9.0	71.4	3.5	3.9	0.073	152	71	
30	M2BAX 200MLA 2	3GBA201410-..F	2959	93.3	93.5	92.9	0.90	51.7	9.5	96.8	3.6	4.0	0.14	250	80	
37	M2BAX 200MLB 2	3GBA201420-..F	2951	93.7	93.9	93.3	0.89	63.9	8.1	120	3.4	3.6	0.16	268	72	
45	M2BAX 225SMA 2	3GBA221210-..F	2960	94.0	94.5	94.6	0.88	78.5	8.9	145	3.6	3.4	0.22	278	76	
55	M2BAX 250SMA 2	3GBA251210-..F	2966	94.3	94.4	94.0	0.87	96.7	7.6	177	3.4	3.1	0.34	335	78	
75	M2BAX 280SMF 2	3GBA281260-..F	2971	94.7	94.7	94.0	0.89	129	7.7	241	2.7	3.3	0.6	527	78	
90	M2BAX 280SMG 2	3GBA281270-..F	2970	95.0	95.3	95.2	0.91	152	8.0	289	3.1	3.3	0.7	576	76	
110	M2BAX 315SMB 2	3GBA311220-..M	2982	95.2	94.9	93.9	0.87	192	7.0	352	1.8	2.7	1.3	801	78	
132	M2BAX 315SMC 2	3GBA311230-..M	2982	95.4	95.4	94.6	0.87	229	6.8	422	2.0	2.8	1.5	852	78	
160	M2BAX 315SMD 2	3GBA311240-..M	2983	95.6	95.6	94.9	0.87	275	7.4	512	2.2	2.8	1.7	909	78	
200	<sup>1)</sup> M2BAX 315MLA 2	3GBA311410-..M	2983	95.8	96.0	95.5	0.88	342	7.5	640	2.3	3.1	2.1	1051	81	
250	M2BAX 355SMA 2	3GBA351210-..M	2985	95.8	95.6	94.6	0.89	423	7.7	800	2.1	3.3	3.0	1412	83	
315	M2BAX 355SMB 2	3GBA351220-..M	2980	95.8	95.7	95.0	0.89	529	7.0	1009	2.1	3.0	3.4	1495	83	
355	M2BAX 355SMC 2	3GBA351230-..M	2984	95.8	95.8	95.0	0.88	605	7.2	1136	2.2	3.0	3.6	1565	83	

<sup>1)</sup> Temperature rise class F

# Technical data

## IE3 General performance cast iron motors

IP 55 - IC 411 - Insulation class F, temperature rise class B  
IE3 efficiency class according to IEC 60034-30-1; 2014

Output kW	Motor type	Product code	Speed r/min	Efficiency IEC 60034-30-1: 2014			Power factor Cos	Current			Torque			Moment of inertia J = 1/4 GD- 2 kgm <sub>2</sub>	Weight kg	Sound pressure Level L <sub>PA</sub> dB
				Full load 100%	3/4 load 75%	1/2 load 50%		I <sub>N</sub> A	I <sub>S</sub> /I <sub>N</sub>	T <sub>N</sub> Nm	T <sub>r</sub> /T <sub>N</sub>	T <sub>b</sub> /T <sub>N</sub>				
<b>1500 r/min = 4 poles</b>				<b>400 V 50 Hz</b>				<b>CENELEC-design</b>								
0.25	M2BAX 71MB 4	3GBA072320--D	1440	73.5	70.1	63.8	0.64	0.78	6.1	1.7	2.7	3.5	0.00075	10	41	
0.37	M2BAX 71MLA 4	3GBA072410--D	1441	77.3	74.9	69.8	0.66	1.06	6.8	2.5	2.7	3.8	0.00098	12	50	
0.55	M2BAX 80MC 4	3GBA082330--D	1445	80.8	80.8	78.1	0.75	1.31	7.8	3.6	2.6	3.9	0.0023	17	48	
0.75	M2BAX 80MLA 4	3GBA082410--D	1427	82.5	82.7	81.5	0.78	1.68	6.7	5.0	2.1	3.2	0.0030	21	49	
1.1	M2BAX 90SB 4	3GBA092120--D	1434	84.1	83.5	82.1	0.73	2.59	7.1	7.3	3.6	4.0	0.0039	23	48	
1.5	M2BAX 90SLA 4	3GBA092010--D	1439	85.3	84.7	82.7	0.78	3.25	8.0	10.0	3.8	4.4	0.0049	25	55	
2.2	M2BAX 100LB 4	3GBA102520--D	1437	86.7	87.6	87.0	0.83	4.38	7.5	14.6	2.7	3.4	0.0086	34	61	
3	M2BAX 100LKA 4	3GBA102810--D	1440	87.7	88.0	87.5	0.82	6.02	8.3	19.9	3.0	3.8	0.012	41	57	
4	M2BAX 112MLA 4	3GBA112410--D	1449	88.6	88.7	87.9	0.80	8.15	9.7	26.5	3.5	4.2	0.015	50	60	
5.5	M2BAX 132SMA 4	3GBA132210--D	1458	89.6	90.2	90.1	0.81	10.9	7.0	36.0	2.3	3.2	0.030	67	68	
7.5	M2BAX 132MLA 4	3GBA132410--D	1456	90.4	90.9	90.6	0.82	14.6	7.6	49.0	2.3	3.4	0.039	84	59	
11	M2BAX 160MLA 4	3GBA162410--F	1477	91.4	91.8	91.1	0.82	21.1	7.6	71.3	2.6	3.3	0.11	136	61	
15	M2BAX 160MLB 4	3GBA162420--F	1472	92.1	92.4	92.1	0.82	28.7	7.9	97.0	2.9	3.3	0.14	161	66	
18.5	M2BAX 180MLA 4	3GBA182410--F	1470	92.6	92.8	92.4	0.79	36.5	9.2	120	3.6	4.1	0.14	169	66	
22	M2BAX 180MLB 4	3GBA182420--F	1470	93.0	93.2	92.9	0.82	41.6	8.9	143	3.7	4.1	0.17	198	65	
30	M2BAX 200MLA 4	3GBA202410--F	1481	93.6	94.0	93.5	0.82	56.3	10.0	193	3.9	3.0	0.32	282	69	
37	M2BAX 225SMA 4	3GBA222210--F	1479	93.9	94.4	94.3	0.84	67.7	7.7	239	3.1	2.9	0.38	278	63	
45	M2BAX 225SMB 4	3GBA222220--F	1481	94.2	94.3	94.0	0.81	85.1	8.2	290	3.7	3.5	0.42	293	67	
55	M2BAX 250SMA 4	3GBA252210--F	1479	94.6	94.7	94.0	0.83	102	10.1	352	4.4	3.4	0.62	386	74	
75	M2BAX 280SMF 4	3GBA282260--F	1481	95.0	95.2	95.1	0.83	137	7.9	484	3.5	3.5	0.96	530	68	
90	M2BAX 280SMG 4	3GBA282270--F	1482	95.2	95.3	95.2	0.85	161	8.4	580	3.8	3.9	1.2	593	68	
110	M2BAX 315SMB 4	3GBA312220--M	1489	95.4	95.4	94.8	0.85	196	7.0	705	2.1	3.0	2.4	823	71	
132	M2BAX 315SMC 4	3GBA312230--M	1488	95.6	95.8	95.3	0.86	231	6.7	847	2.2	2.9	2.9	892	71	
160	M2BAX 315SMD 4	3GBA312240--M	1488	95.8	96.0	95.8	0.85	282	6.9	1026	2.2	3.0	3.2	933	71	
200	M2BAX 315MLB 4	3GBA312420--M	1487	96.0	96.4	96.4	0.86	351	6.8	1284	2.4	3.0	3.9	1091	74	
250	M2BAX 355SMA 4	3GBA352210--M	1491	96.0	96.0	95.6	0.86	435	6.4	1601	2.1	2.9	5.9	1445	78	
315	M2BAX 355SMB 4	3GBA352220--M	1491	96.0	96.0	95.6	0.86	545	6.7	2018	2.3	3.0	6.9	1595	78	
355	M2BAX 355SMC 4	3GBA352230--M	1490	96.0	96.2	95.8	0.86	616	6.3	2273	2.3	2.8	7.2	1635	78	

# Technical data

## IE3 General performance cast iron motors

IP 55 - IC 411 - Insulation class F, temperature rise class B

IE3 efficiency class according to IEC 60034-30-1; 2014

Output kW	Motor type	Product code	Speed r/min	Efficiency IEC 60034-30-1: 2014			Power factor Cos	Current		Torque			Moment of inertia J = 1/4 GD- 2 kgm <sub>2</sub>	Weight kg	Sound pressure Level L <sub>PA</sub> dB
				Full load 100%	3/4 load 75%	1/2 load 50%		I <sub>n</sub> A	I <sub>s</sub> /I <sub>n</sub>	T <sub>N</sub> Nm	T <sub>r</sub> /T <sub>N</sub>	T <sub>b</sub> /T <sub>N</sub>			
1000 r/min = 6 poles				400 V 50 Hz				CENELEC-design							
0.18	M2BAX 71MB 6	3GBA073320--D	931	63.9	60.0	53.2	0.69	0.60	3.8	1.9	2.1	2.6	0.0010	10	39
0.25	M2BAX 71MLA 6	3GBA073410--D	926	68.6	66.3	60.9	0.67	0.80	4.3	2.6	2.6	2.9	0.0014	13	46
0.37	M2BAX 80MC 6	3GBA083330--D	940	73.5	71.2	66.4	0.67	1.08	5.8	3.8	2.8	3.2	0.0024	17	42
0.55	M2BAX 80MLA 6	3GBA083410--D	943	77.2	75.9	71.9	0.68	1.54	6.3	5.6	3.4	3.5	0.0035	23	48
0.75	M2BAX 90SLA 6	3GBA093010--D	941	78.9	78.0	75.2	0.68	2.02	4.6	7.6	2.4	2.9	0.0044	23	50
1.1	M2BAX 90LB 6	3GBA093520--D	946	81.0	80.0	77.0	0.66	2.97	5.4	11.0	3.0	3.6	0.0064	30	53
1.5	M2BAX 100LKA 6	3GBA103810--D	952	82.5	82.3	80.3	0.72	3.64	5.6	15.1	2.3	3.1	0.0098	37	51
2.2	M2BAX 112MLA 6	3GBA113410--D	951	84.3	84.2	82.6	0.71	5.31	5.8	22.0	2.7	3.5	0.013	46	51
3	M2BAX 132SMA 6	3GBA133210--D	968	85.6	86.1	84.9	0.68	7.40	6.7	29.6	2.1	3.2	0.029	65	48
4	M2BAX 132SMB 6	3GBA133220--D	971	86.8	86.3	84.3	0.70	9.50	6.6	39.4	2.5	3.5	0.034	71	61
5.5	M2BAX 132MLA 6	3GBA133410--D	974	88.0	88.5	88.3	0.67	13.5	5.0	53.9	1.9	2.8	0.051	97	65
7.5	M2BAX 160MLA 6	3GBA163410--F	979	89.1	89.5	88.9	0.75	15.9	7.6	73.4	1.8	3.1	0.099	131	59
11	M2BAX 160MLB 6	3GBA163420--F	976	90.3	91.3	91.3	0.78	22.5	7.8	108	1.9	3.0	0.13	161	57
15	M2BAX 180MLA 6	3GBA183410--F	971	91.2	91.8	91.2	0.75	31.8	9.4	146	2.3	3.6	0.16	197	63
18.5	M2BAX 200MLA 6	3GBA203410--F	979	91.7	91.9	91.1	0.75	38.8	6.9	180	2.2	3.3	0.21	208	62
22	M2BAX 200MLB 6	3GBA203420--F	979	92.2	92.4	92.1	0.76	45.3	6.6	215	2.1	3.1	0.26	251	65
30	M2BAX 225SMA 6	3GBA223210--F	987	92.9	93.2	92.9	0.81	57.4	7.1	290	2.6	2.9	0.59	286	65
37	M2BAX 250SMA 6	3GBA253210--F	986	93.3	93.6	93.1	0.79	72.4	8.5	353	3.3	3.0	0.83	360	64
45	M2BAX 280SMF 6	3GBA283260--F	986	93.7	94.2	93.9	0.80	86.6	7.7	434	3.2	3.0	1.6	524	62
55	M2BAX 280SMG 6	3GBA283270--F	991	94.1	94.3	94.0	0.81	104	7.8	531	3.1	3.1	1.8	563	66
75	M2BAX 315SMB 6	3GBA313220--M	994	94.6	94.9	94.6	0.84	136	6.8	720	1.8	2.6	4.1	791	75
90	M2BAX 315SMC 6	3GBA313230--M	994	94.9	95.1	94.7	0.84	164	7.2	864	2.0	3.0	4.6	859	76
110	M2BAX 315SMD 6	3GBA313240--M	994	95.1	95.3	95.0	0.83	200	7.3	1056	2.2	3.1	4.9	912	75
132	M2BAX 315MLB 6	3GBA313420--M	995	95.4	95.5	95.1	0.82	242	7.3	1266	2.3	3.2	6.3	1068	72
160	M2BAX 355SMA 6	3GBA353210--M	993	95.6	95.9	95.6	0.82	292	6.7	1538	2.5	2.6	7.9	1348	75
200	M2BAX 355SMB 6	3GBA353220--M	993	95.8	96.2	96.1	0.82	365	6.7	1923	2.6	2.5	9.7	1512	75
250	M2BAX 355SMC 6	3GBA353230--M	993	95.8	96.1	95.8	0.81	464	7.7	2404	3.0	3.1	11.3	1656	75

# Variant codes

## IE4 General performance cast iron motors

Variant codes specify additional options and features to the standard motor.

The desired features are listed as three-digit variant codes in the motor order.

Note also that there are variants that cannot be used together.

Code/Variants	Frame size												
	80	90	100	112	132	160	180	200	225	250	280	315	355
<b>Administration</b>													
531	Sea freight packing	•	•	•	•	•	•	•	•	•	•	•	•
<b>Bearings and Lubrication</b>													
037	Roller bearing at D-end.	-	-	-	-	•	•	•	•	•	•	•	•
041	Bearings regreasable via grease nipples.	-	-	-	-	•	•	•	•	•	○	○	○
043	SPM compatible nipples for vibration measurement	•	•	•	•	•	•	•	•	•	•	•	•
<b>Branch standard designs</b>													
178	Stainless steel / acid proof bolts.	•	•	•	•	•	•	•	•	•	•	•	•
<b>Cooling system</b>													
068	Light alloy metal fan	•	•	•	•	•	•	•	•	•	•	•	•
183	Separate motor cooling (fan axial, N-end).	•	•	•	•	•	•	•	•	•	•	•	-
<b>Heating elements</b>													
451	Heating element, 200 - 240 V	•	•	•	•	•	•	•	•	•	•	•	•
<b>Mounting arrangements</b>													
008	IM 2101 foot/flange mounted, IEC flange, from IM 1001 (B34 from B3).	•	•	•	•	•	-	-	-	-	-	-	-
009	IM 2001 foot/flange mounted, IEC flange, from IM 1001 (B35 from B3).	•	•	•	•	•	•	•	•	•	•	•	•
047	IM 3601 flange mounted, IEC flange, from IM 3001 (B14 from B5).	•	•	•	•	•	-	-	-	-	-	-	-
066	Modified for specified mounting position differing from IM B3 (1001), IM B5 (3001), B14 (3601), IM B35 (2001), IM B34 (2101)	•	•	•	•	•	•	•	•	•	•	•	•
<b>Painting</b>													
114	Special paint color, standard grade	•	•	•	•	•	•	•	•	•	•	•	•
<b>Protection</b>													
005	Protective roof	•	•	•	•	•	•	•	•	•	•	•	•
072	Radial seal at D-end. Not possible for 2-pole , 280 and 315 frames	•	•	•	•	•	•	•	•	•	•	•	-
158	Degree of protection IP65.	•	•	•	•	•	•	•	•	•	•	•	•
403	Degree of protection IP56.	•	•	•	•	•	•	•	•	•	•	•	•
<b>Rating &amp; instruction plates</b>													
002	Restamping voltage, frequency and output, continuous duty.	•	•	•	•	•	•	•	•	•	•	•	•
135	Mounting of additional identification plate, stainless.	•	•	•	•	•	•	•	•	•	•	•	•
159	Additional plate with text "Made in ...."	•	•	•	•	•	•	•	•	•	•	•	•
161	Additional rating plate delivered loose.	•	•	•	•	•	•	•	•	•	•	•	•
163	Frequency converter rating plate. Rating data according to quotation.	•	•	•	•	•	•	•	•	•	•	•	•
181	Rating plate with ABB standard loadability values for VSD operation. Other auxiliaries for VSD operation to be selected as necessary.	•	•	•	•	•	•	•	•	•	•	•	•
<b>Standards and Regulations</b>													
331	IE1 motor not for sale for use in EU	•	•	•	•	•	•	•	•	•	•	•	•
540	China energy label	•	•	•	•	•	•	•	•	•	•	•	•
585	Safety certificate for Morocco	•	•	•	•	•	•	•	•	•	•	•	•
823	WIMES 3.03i6 Compliant Design for VSD operation	•	•	•	•	•	•	•	•	•	•	•	•
<b>Stator winding temperature sensors</b>													
439	PTC - thermistors (2x3 in series), 150 °C, in stator winding	•	•	•	•	•	•	•	•	•	•	•	•
445	Pt100 2-wire in stator winding, 1 per phase	•	•	•	•	•	•	•	•	•	•	•	•
<b>Terminal box</b>													
022	Cable entry LHS (seen from D-end).	•	•	•	•	•	•	•	•	•	•	•	•
230	Standard metal cable gland.	•	•	•	•	•	•	•	•	•	•	•	•
468	Cable entry from D-end.	•	•	•	•	•	•	•	•	•	•	•	•
469	Cable entry from N-end.	•	•	•	•	•	•	•	•	•	•	•	•
<b>Testing</b>													
145	Type test report from a catalogue motor, 400V 50Hz.	•	•	•	•	•	•	•	•	•	•	•	•
148	Routine test report.	•	•	•	•	•	•	•	•	•	•	•	•
<b>Variable speed drives</b>													
701	Insulated bearing at N-end.	-	-	-	-	-	-	-	-	-	•	•	•
704	EMC cable entry.	•	•	•	•	•	•	•	•	•	•	•	•

○ = Included as standard | • = Available as option | - = Not applicable

# Variant codes

## IE3 General performance cast iron motors

Variant codes specify additional options and features to the standard motor. The desired features are listed as three-digit variant codes in the motor order. Note also that there are variants that cannot be used together. For details please contact your ABB sales office before making an order.

Code/Variants	Frame size													
	71	80	90	100	112	132	160	180	200	225	250	280	315	355
<b>Administration</b>														
531	Sea freight packing	•	•	•	•	•	•	•	•	•	•	•	•	•
683	Prepared for ABB Ability Smart Sensor	-	-	-	-	-	•	•	•	•	•	•	•	•
684	ABB Ability Smart sensor mounted	-	-	-	-	-	•	•	•	•	•	•	•	•
865	One-year extension on standard warranty	•	•	•	•	•	•	•	•	•	•	•	•	•
<b>Bearings and Lubrication</b>														
037	Roller bearing at D-end.	-	-	-	-	-	•	•	•	•	•	•	•	•
041	Bearings regreasable via grease nipples.	-	-	-	-	-	•	•	•	•	•	○	○	○
043	SPM compatible nipples for vibration measurement	-	-	-	-	-	•	•	•	•	•	•	•	•
188	63-series bearing in D-end	-	-	-	-	-	•	•	•	•	•	-	-	-
<b>Branch standard designs</b>														
178	Stainless steel / acid proof bolts.	•	•	•	•	•	•	•	•	•	•	•	•	•
<b>Cooling system</b>														
068	Light alloy metal fan	•	•	•	•	•	•	•	•	•	•	•	•	•
183	Separate motor cooling (fan axial, N-end).	•	•	•	•	•	•	•	•	•	•	•	•	-
<b>Earthing Bolt</b>														
067	External earthing bolt.	○	○	○	○	○	○	○	○	○	○	○	○	○
<b>Heating elements</b>														
450	Heating element, 100-120 V	•	•	•	•	•	•	•	•	•	•	•	•	•
451	Heating element, 200 - 240 V	•	•	•	•	•	•	•	•	•	•	•	•	•
<b>Marine</b>														
096	Fulfilling Lloyds Register of Shipping (LR) requirements, without certificate (non-essential duty only)	•	•	•	•	•	•	•	•	•	•	•	•	•
186	Fulfilling Det Norske Veritas (DNV) requirements, without certificate	•	•	•	•	•	•	•	•	•	•	•	•	•
492	Fulfilling Registro Italiano Navale (RINA) requirements, without certificate.	•	•	•	•	•	•	•	•	•	•	•	•	•
496	Fulfilling Bureau Veritas (BV) requirements, without certificate (non-essential duty only)	•	•	•	•	•	•	-	-	-	-	-	-	-
675	Fulfilling American Bureau of Shipping (ABS) requirements, without certificate (non-essential duty only)	•	•	•	•	•	•	-	-	-	-	-	-	-
<b>Mounting arrangements</b>														
008	IM 2101 foot/flange mounted, IEC flange, from IM 1001 (B34 from B3).	•	•	•	•	•	•	-	-	-	-	-	-	-
009	IM 2001 foot/flange mounted, IEC flange, from IM 1001 (B35 from B3).	•	•	•	•	•	•	•	•	•	•	•	•	•
047	IM 3601 flange mounted, IEC flange, from IM 3001 (B14 from B5).	•	•	•	•	•	•	-	-	-	-	-	-	-
066	Modified for specified mounting position differing from IM B3 (1001), IM B5 (3001), B14 (3601), IM B35 (2001), IM B34 (2101)	•	•	•	•	•	•	•	•	•	•	•	•	•
<b>Painting</b>														
111	Painting system C3, durability Medium	○	○	○	○	○	○	○	○	○	○	○	○	○
114	Special paint color, standard grade	•	•	•	•	•	•	•	•	•	•	•	•	•
<b>Protection</b>														
005	Protective roof	•	•	•	•	•	•	•	•	•	•	•	•	•
072	Radial seal at D-end. Not possible for 2-pole, 280 and 315 frames	•	•	•	•	•	•	•	•	•	•	•	•	•
158	Degree of protection IP65.	•	•	•	•	•	•	•	•	•	•	•	•	•
403	Degree of protection IP56.	•	•	•	•	•	•	•	•	•	•	•	•	•
784	Gamma-seal at D-end.	•	•	•	•	•	•	-	-	-	-	-	-	-
<b>Rating &amp; instruction plates</b>														
002	Restamping voltage, frequency and output, continuous duty.	•	•	•	•	•	•	•	•	•	•	•	•	•
095	Restamping output (maintained voltage, frequency), intermittent duty.	•	•	•	•	•	•	•	•	•	•	•	•	•
098	Stainless rating plate.	○	○	○	○	○	○	○	○	○	○	○	○	○
135	Mounting of additional identification plate, stainless.	•	•	•	•	•	•	•	•	•	•	•	•	•
159	Additional plate with text "Made in ...."	-	-	-	-	-	•	•	•	•	•	•	•	•
161	Additional rating plate delivered loose.	•	•	•	•	•	•	•	•	•	•	•	•	•
163	Frequency converter rating plate. Rating data according to quotation.	•	•	•	•	•	•	•	•	•	•	•	•	•

Code/Variants		Frame size													
		71	80	90	100	112	132	160	180	200	225	250	280	315	355
181	Rating plate with ABB standard loadability values for VSD operation. Other auxiliaries for VSD operation to be selected as necessary.	•	•	•	•	•	•	•	•	•	•	•	•	•	•
818	Restamping as generator	-	-	-	-	-	-	•	•	•	•	•	•	•	•
<b>Standards and Regulations</b>															
331	IE1 motor not for sale for use in EU	•	•	•	•	•	•	•	•	•	•	•	•	•	•
540	China energy label	•	•	•	•	•	•	•	•	•	•	•	•	•	•
586	Fulfilling UK Conformity Assessment (UKCA) requirements.	•	•	•	•	•	•	•	•	•	•	•	•	•	•
822	WIMES 3.03i6 Compliant Design for DOL operation	•	•	•	•	•	•	-	-	-	-	-	-	-	-
823	WIMES 3.03i6 Compliant Design for VSD operation	•	•	•	•	•	•	•	•	•	•	•	•	•	•
<b>Stator winding temperature sensors</b>															
122	Bimetal detectors, break type (NCC), (3 in series), 150 °C, in stator winding	•	•	•	•	•	•	•	•	•	•	•	•	•	•
435	PTC - thermistors (3 in series), 130 °C, in stator winding	•	•	•	•	•	•	•	•	•	•	•	•	•	•
436	PTC - thermistors (3 in series), 150 °C, in stator winding	○	○	○	○	○	○	○	○	○	○	○	○	○	○
439	PTC - thermistors (2x3 in series), 150 °C, in stator winding	•	•	•	•	•	•	•	•	•	•	•	•	•	•
445	Pt100 2-wire in stator winding, 1 per phase	•	•	•	•	•	•	•	•	•	•	•	•	•	•
<b>Terminal box</b>															
022	Cable entry LHS (seen from D-end).	•	•	•	•	•	•	•	•	•	•	•	•	•	•
230	Standard metal cable gland.	•	•	•	•	•	•	•	•	•	•	•	•	•	•
375	"Standard plastic cable gland (to close from Nov 1st)"	-	-	-	-	-	-	•	•	•	•	•	-	-	-
400	4 x 90 degr turnable terminal box.	•	•	•	•	•	•	○	○	○	○	○	○	○	○
418	"Separate terminal box for auxiliaries, standard material. (to close from Nov 1st)"	-	-	-	-	-	-	•	•	•	•	•	-	-	-
447	Top mounted separate terminal box for monitoring equipment.	-	-	-	-	-	-	-	-	-	-	-	•	•	•
468	Cable entry from D-end.	-	-	-	-	-	-	-	-	-	-	-	•	•	•
731	"Two standard metal cable glands. (to close from Nov 1st)"	-	-	-	-	-	-	•	•	•	•	•	•	•	•
<b>Testing</b>															
145	Type test report from a catalogue motor, 400 V 50 Hz.	•	•	•	•	•	•	-	-	-	-	-	-	-	-
148	Routine test report.	•	•	•	•	•	•	•	•	•	•	•	•	•	•
<b>Variable speed drives</b>															
472	1024 pulse tachometer (L&L 861007455-1024).	-	-	-	-	-	-	•	•	•	•	•	-	-	-
473	2048 pulse tachometer (L&L 861007455-2048).	-	-	-	-	-	-	•	•	•	•	•	-	-	-
701	Insulated bearing at N-end.	-	-	-	-	-	-	-	-	-	-	-	•	•	•
704	EMC cable entry.	•	•	•	•	•	•	•	•	•	•	•	•	•	•

○ = Included as standard | • = Available as option | - = Not applicable

# Mechanical design

## Bearings

General performance motors are normally fitted with single-row deep-groove ball bearings, as shown in the table below.

If the bearing at the D-end is replaced with a roller bearing (NU- or NJ-), higher radial forces can be handled. Roller bearings are suitable for belt-drive applications and can be ordered with variant code 037.

Motor size	Poles	Standard design		Alternative design
		Deep groove ball bearings		Deep groove ball bearings
		D-end	N-end	Roller bearings (VC037) D-end
71	2 - 6	6203-2Z/C3	6202-2Z/C3	-
80 IE3	2 - 6	6204-2Z/C3	6203-2Z/C3	-
80 IE4	2 - 6	6204-2Z/C3	6204-2Z/C3	-
90 IE3	2 - 6	6205-2Z/C3	6204-2Z/C3	-
90 IE4	2 - 6	6205-2Z/C3	6205-2Z/C3	-
100 IE3	2 - 6	6206-2Z/C3	6205-2Z/C3	-
100 IE4	2 - 6	6206-2Z/C3	6206-2Z/C3	-
112 IE3	2 - 6	6206-2Z/C3	6205-2Z/C3	-
112 IE4	2 - 6	6207-2Z/C3	6206-2Z/C3	-
132 IE3	2 - 6	6208-2Z/C3	6208-2Z/C3	-
132 IE4	2 - 6	6208-2Z/C3	6208-2Z/C3	-
160 IE3	2 - 6	6209-2Z/C3	6209-2Z/C3	NU 309 ECP/C3
160 IE4	2 - 6	6309-2Z/C3	6209-2Z/C3	NU 309ECP/C3
180 IE3	2 - 6	6210-2Z/C3	6209-2Z/C3	NU 310 ECP/C3
180 IE4	2 - 6	6310-2Z/C3	6210-2Z/C3	NU 310ECP/C3
200 IE3	2 - 6	6212-2Z/C3	6209-2Z/C3	NU 312 ECP/C3
200 IE4	2 - 6	6312-2Z/C3	6212-2Z/C3	NU 312ECP/C3
225 IE3	2 - 6	6213-2Z/C3	6210-2Z/C3	NU 313 ECP/C3
225 IE4	2 - 6	6313-2Z/C3	6213-2Z/C3	NU 313ECP/C3
250 IE3	2 - 6	6215-2Z/C3	6212-2Z/C3	NU 315 ECP/C3
250 IE4	2 - 6	6315-2Z/C3	6215-2Z/C3	NU 315ECP/C3
280 IE3, IE4	2 - 6	6316/C3	6316/C3	NU 316 ECP/C3
315 IE3	2	6217/C3	6217/C3	NU 217 ECP/C3
315 IE3	4 - 6	6219/C3	6217/C3	NU 219 ECP/C3
315 IE4	2	6316/C3	6316/C3	NU 316ECP/C3
315 IE4	4 - 6	6319/C3	6316/C3	NU 319ECP/C3
355 IE3	2	6219/C3	6219/C3	NU 219 ECP/C3
355 IE3	4 - 6	6222/C3	6219/C3	NU 222 ECP/C3
355 IE4	2	6316/C3	6316/C3	NU 316ECP/C3
355 IE4	4 - 6	6322/C3	6316/C3	NU 322ECP/C3

### Axially-locked bearings

All motors are equipped as standard with an axially locked bearing at the D-end.

# Mechanical design

## Radial forces

### Permissible loading on the shaft

The following table shows permissible radial forces on the shaft in Newtons, assuming zero axial force, a 25 °C ambient temperature, and normal conditions. The values are given for a calculated bearing life of 20 000 and 40 000 hours per motor size.

These calculated values further assume mounting position IM B3 (foot-mounted), with force directed sideways. In some cases, the strength of the shaft affects permissible forces.

Permissible loads of simultaneous radial and axial forces can be supplied on request.

If the radial force is applied between points  $X_0$  and  $X_{max}$ , the permissible force  $F_R$  can be calculated with the following formula:

$$F_R = F_{X0} - \frac{X}{E} (F_{X0} - F_{Xmax})$$

---

#### Where

E length of the shaft extension in the standard version

---

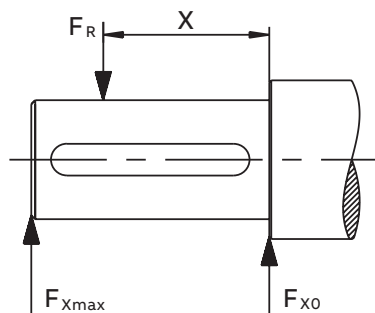



## Permissible radial forces for IE4 motors

### Permissible radial forces for IE4 motors

Motor size	Poles	Length of shaft extension E (mm)	Mounting arrangement IM B3			
			Deep groove ball bearings			
			20,000 h		40,000 h	
			$F_{x0}$	$F_{xmax}$	$F_{x0}$	$F_{xmax}$
80	2	40	725	610	575	480
	4	40	925	790	730	625
	6	40	1060	905	835	715
90S	2	50	785	640	490	400
90SL	2	50	800	675	495	420
	4	50	1005	850	790	670
	6	50	1155	975	910	770
100	2	60	1115	940	840	710
	4	60	1390	1175	1090	920
	6	60	1610	1360	1270	1070
112	2	60	1470	1250	1160	985
	4	60	1845	1565	1450	1230
	6	60	2115	1795	1670	1415
132S	2	80	1635	1295	1290	1020
	4	80	2040	1615	1600	1270
	6	80	2350	1865	1850	1465
132SM	2	80	1655	1350	1300	1060
	4	80	2055	1675	1605	1310
	6	80	2350	1920	1840	1500
160	2	110	3045	2420	2385	1900
	4	110	3835	3120	3000	2440
	6	110	4360	3545	3405	2770
180	2	110	3535	2900	2775	2275
	4	110	4450	3650	3490	2865
	6	110	5045	4135	3950	3235
200	2	110	4575	3825	3570	2990
	4	110	5840	4885	4575	3830
	6	110	6660	5570	5215	4360
225	2	110	5290	4480	4145	3510
	4	140	6635	5400	5195	4225
	6	140	7560	6150	5910	4805
250	2	140	6500	5305	5100	4160
	4	140	8125	6630	6365	5190
	6	140	9230	7530	7215	5885
280	2	140	6650	5525	5170	4295
	4	140	8365	7140	6470	5525
	6	140	9525	7910	7390	6140
315SM	2	140	6430	5480	4940	4210
	4	170	9810	8100	7570	6250
	6	170	11035	9110	8470	6995
315ML	2	140	6340	5500	4825	4190
	4	170	9735	8215	7470	6300
	6	170	10920	9215	8325	7020
315LK	4	170	9935	8510	7645	6550
	6	170	11105	9515	8485	7270
355SM	2	140	5850	5130	4350	3815
	4	210	12130	10015	9205	7600
	6	210	13740	11345	10395	8580
355ML	2	140	6220	5520	4705	4175
	4	210	12465	10480	9510	8000
	6	210	14060	11820	10675	8980

## Permissible radial forces for IE3 motors

### Permissible radial forces for IE3 motors

Motor size	Poles	Length of shaft extension E (mm)	Basic design with deep groove ball bearings				Basic design with deep groove roller bearings			
			20,000 h		40,000 h		20,000 h		40,000 h	
			$F_{x0}$ (N)	$F_{xmax}$ (N)	$F_{x0}$ (N)	$F_{xmax}$ (N)	$F_{x0}$ (N)	$F_{xmax}$ (N)	$F_{x0}$ (N)	$F_{xmax}$ (N)
71	2	30	545	465	430	370				
	4	30	685	585	545	465				
	6	30	785	660	620	530				
80	2	40	740	620	585	490				
	4	40	925	775	730	615				
	6	40	1065	890	840	705				
90S	2	50	795	645	625	510				
	4	50	1000	815	790	645				
	6	50	1145	935	905	740				
90L	2	50	795	660	630	520				
	4	50	1005	830	790	655				
	6	50	1150	950	910	750				
100	2	60	1110	895	875	705				
	4	60	1395	1120	1100	885				
	6	60	1605	1290	1265	1020				
112	2	60	1120	925	885	730				
	4	60	1405	1160	1105	915				
	6	60	1615	1335	1275	1050				
132S	2	80	1630	1270	1285	1000				
	4	80	2055	1600	1620	1260				
	6	80	2360	1840	1860	1450				
132M	4	80	2075	1665	1630	1310				
	6	80	2375	1905	1865	1495				
	2	110	1945	1510	1545	1195				
160	4	110	2455	1905	1945	1510				
	6	110	2835	2250	2245	1780				
	2	110	2095	1705	1660	1350				
180	4	110	2640	2145	2090	1700				
	6	110	3025	2460	2395	1950				
	2	110	2800	2350	2200	1830				
200	4	110	3550	2910	2810	2305				
	6	110	4065	3335	3220	2640				
	2	110	3335	2795	2640	2215				
225	4	140	4200	3370	3325	2670				
	6	140	4810	3860	2805	3055				
	2	140	3965	3220	3140	2550				
250	4	140	4995	4060	3995	3215				
	6	140	5715	4645	4525	3675				
	2	140	6590	5500	5100	4250	22700	7200	18350	7200
280	4	140	8310	6930	6430	5360	27900	9500	22550	9500
	6	140	9460	7890	7310	6090	31550	9500	25450	9500
	2	140	4900	4150	3850	3250	14900	6650	12100	6650
315	4	170	8000	6650	6350	5250	21200	10350	17200	10350
	6	170	9150	7550	7200	5950	23900	10250	19400	10250
	2	140	6250	5500	4900	4300	17200	7850	13950	7850
355	4	210	10500	8700	8250	6800	28050	16250	22750	16250
	6	210	12000	9900	9400	7750	31650	16200	25700	16200

# Mechanical design

## Axial forces

—  
01 Mounting arrangement IM B3

—  
02 Mounting arrangement IM V1

The following tables present permissible axial forces on the shaft in Newtons, assuming zero radial force, a 25 °C ambient temperature, and normal conditions. The values are given for a calculated bearing life of 20,000 and 40,000 hours per motor size.

At 60 Hz, the values must be reduced by 10 percent, and for two-speed motors, the higher speed determines permissible axial force. Permissible loads of simultaneous radial and axial forces can be supplied on request.

For axial force  $F_{AD}$ , it is assumed that the D-bearing is locked with a locking ring.

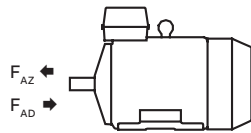

—  
01

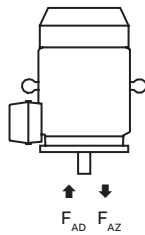

—  
02

## Permissible axial forces for IE4 motors

### Permissible axial forces for IE4 motors

Motor size	Poles	Length of shaft extension E (mm)	Mounting arrangement IM B3			
			Deep groove ball bearings			
			20,000 h		40,000 h	
			$F_{AD}$	$F_{AZ}$	$F_{AD}$	$F_{AZ}$
80	2	40	790	390	645	245
	4	40	980	580	790	390
	6	40	1125	725	895	495
90	2	50	915	355	755	195
	4	50	1125	565	915	355
	6	50	1275	715	1030	470
100	2	60	1200	540	980	320
	4	60	1480	820	1190	530
	6	60	1695	1035	1355	695
112	2	60	1485	825	1195	535
	4	60	1860	1200	1480	820
	6	60	2140	1480	1690	1030
132	2	80	1725	845	1400	520
	4	80	2135	1255	1705	825
	6	80	2440	1560	1935	1055
160	2	110	2705	2005	2110	1410
	4	110	3475	2775	2685	1985
	6	110	4020	3320	3095	2395
180	2	110	3150	2350	2455	1655
	4	110	4050	3250	3130	2330
	6	110	4680	3880	3605	2805
200	2	110	3995	3095	3095	2195
	4	110	5195	4295	4000	3100
	6	110	6035	5135	4630	3730
225	2	110	4415	3665	3390	2640
	4	140	5730	4980	4375	3625
	6	140	6670	5920	5085	4335
250	2	140	5480	4320	4240	3080
	4	140	7065	5905	5420	4260
	6	140	8195	7035	6270	5110
280	2	140	6095	4095	4785	2785
	4	140	7765	5765	6020	4020
	6	140	8990	6990	6935	4935
315SM	2	140	6025	4025	4720	2720
	4	170	8880	6880	6840	4840
	6	170	10225	8225	7815	5815
315ML	2	140	5955	3955	4655	2655
	4	170	8800	6800	6760	4760
	6	170	10115	8115	7710	5710
315LK	4	170	8840	6840	6805	4805
	6	170	10145	8145	7745	5745
355SM	2	140	5630	3915	4340	2630
	4	210	10650	8940	8065	6350
355ML	6	210	12365	10655	9305	7590
	2	140	5755	4040	4460	2745
	4	210	10740	9025	8145	6435
	6	210	12440	10730	9375	7660

## Permissible axial forces for IE3 motors

### Permissible axial forces for IE3 motors

Motor size	Poles	Length of shaft extension E (mm)	Mounting arrangement IM B3				Mounting arrangement IM V1			
			Deep groove ball bearings				Deep groove ball bearings			
			20,000 h		40,000 h		20,000 h		40,000 h	
			F <sub>AD</sub> (N)	F <sup>Az</sup> (N)	F <sub>AD</sub> (N)	F <sup>Az</sup> (N)	F <sub>AD</sub> (N)	F <sup>Az</sup> (N)	F <sub>AD</sub> (N)	F <sup>Az</sup> (N)
71	2	30	580	300	465	185				
	4	30	725	445	580	300				
	6	30	810	530	670	390				
80	2	40	750	430	595	275				
	4	40	940	620	750	430				
	6	40	1055	735	870	550				
90	2	50	845	445	675	275				
	4	50	1050	650	840	440				
	6	50	1175	775	935	535				
100	2	60	1175	615	940	380				
	4	60	1465	905	1175	615				
	6	60	1640	1080	1305	745				
112	2	60	1175	615	935	375				
	4	60	1460	900	1170	610				
	6	60	1635	1075	1300	740				
132	2	80	1750	950	1400	600	1900	850	1550	500
	4	80	2200	1400	1750	950	2400	1250	1950	800
160	2	110	1750	1050	1400	700	2050	800	1700	400
	4	110	2200	1500	1700	1050	2650	1150	2200	650
	6	110	2550	1850	2000	1300	2950	1500	2400	950
180	2	110	1800	1100	1450	750	2300	800	1900	400
	4	110	2300	1600	1750	1100	2950	1100	2450	600
	6	110	2650	2000	2050	1400	3300	1550	2700	950
200	2	110	2300	1600	1800	1100	2950	1150	2400	650
	4	110	2950	2300	2300	1600	3850	1650	3200	1000
	6	110	3450	2750	2600	1950	4450	2000	3600	1200
225	2	110	2500	2100	1900	1500	3250	1600	2650	1000
	4	140	3250	2850	2450	2050	4150	2150	3350	1350
	6	140	3800	3400	2850	2500	5000	2650	4050	1700
250	2	140	2950	2450	2250	1750	3950	1800	3200	1100
	4	140	3850	3350	2950	2400	5100	2550	4150	1600
	6	140	4500	3950	3400	2850	6100	2900	5000	1750
280	2	140	6060	4060	4530	2530	6990	3840	5630	2480
	4	140	7380	5380	6010	4010	9100	5295	7285	3480
	6	140	8850	6850	6710	4710	10600	6375	8475	4250
315	2	140	4150	2150	3300	1300	6100	450	-	-
	4	170	6600	4600	5100	3100	9250	2300	7700	750
	6	170	7550	5550	5800	3800	10850	2600	9050	750
355	2	140	4900	3200	3800	2100	8300	600	-	-
	4	210	8050	6300	6100	4350	12750	2700	10750	700
	6	210	9250	7500	6950	5200	14650	2950	12300	600

# Terminal box

## Standard terminal box

### Standard delivery

Standard delivery if no other information is provided.

Motor size	Pole number	Amount and size of threads	Cable outer diameter rmm	Single core cross-section mm <sup>2</sup> /phase	Terminal bolt size 6x
71	2-8	2xM16x1.5, M16x1.5	2xØ5-9, Ø5-9	2,5	M4
80-90	2-8	2xM25x1.5, M16x1.5	2xØ11-16, Ø5-9	4	M4
100-132	2-8	2xM32x1.5, M16x1.5	2xØ14-21, Ø5-9	10	M5
160-180	2-8	2xM40x1.5, M16x1.5	2xØ19-27, Ø5-9	35	M6
200 (IE3)	2-8	2xM40x1.5, M16x1.5	2xØ19-27, Ø5-9	35	M6
200 (IE4)	2-8	2xM63x1.5, M16x1.5	2xØ37-44, Ø5-9	70	M10
220-250	2-8	2xM63x1.5, M16x1.5	2xØ37-44, Ø5-9	70	M10
280	2-8	2xM63x1.5, 2xM20x1.5	2xØ37-44, 2xØ8-14	2x150	M10
315	2-8	2xM63x1.5, 2xM20x1.5	2xØ37-44, 2xØ8-14	2x240	M12
355	2-8	2xM75x1.5, 2xM20x1.5	2xØ48-60, 2xØ8-14	4x240	M12

Shaft height	Earthing on frame	Earthing in main terminal box
71-132	M5	M5
160-250	M6	M6
280-355	M10	M10

## Terminal boxes

The pictures below show standard terminal boxes.

—  
01 Terminal box for sizes  
71 to 132



—  
01

—  
02 Terminal box for sizes  
160 to 180.



—  
05

—  
03 Terminal box for sizes  
200 to 250



—  
04 Terminal box for sizes  
280 to 355



—  
05 Terminal board for  
sizes 71 to 132

—  
06 Terminal board for  
sizes 160 to 180

—  
07 Terminal board for  
sizes 200 to 250

—  
08 Terminal board for  
sizes 280 to 355



—  
02

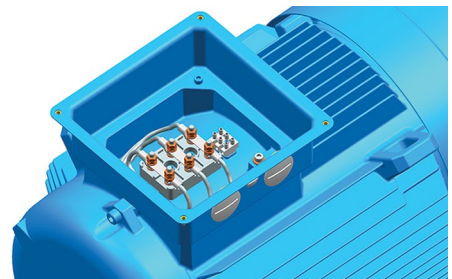
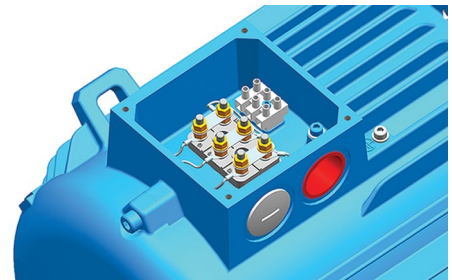

—  
06

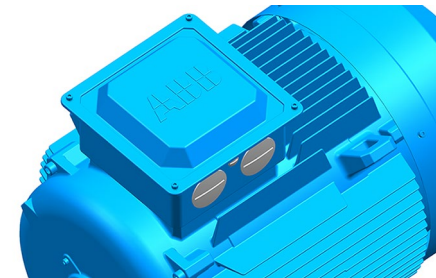

—  
03

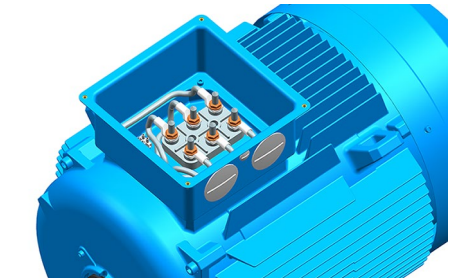

—  
07

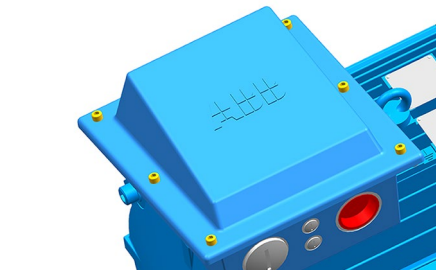

—  
04

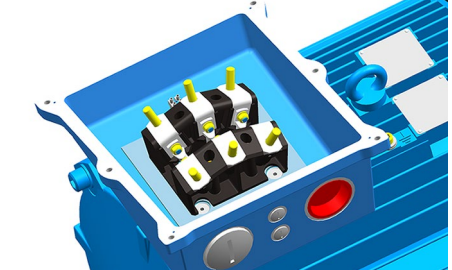

—  
08

# Dimension drawings

## IE4 General performance cast iron motors

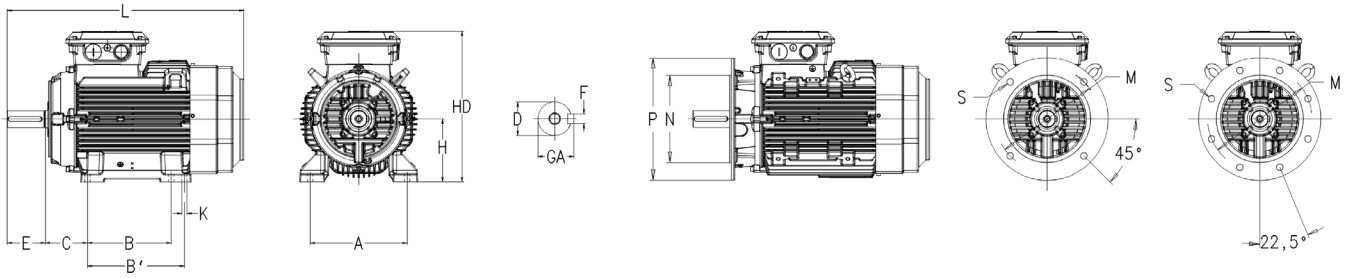

Foot-mounted motor IM1001, B3 and flange-mounted motor IM3001, B5

Motor size	D		GA		F		E		L max		A	B	B'	C	HD	K	M	N	P	S
	Poles		Poles		Poles		Poles		Poles											
	2	4-6	2	4-6	2	4-6	2	4-6	2	4-6										
80M	19	19	21.5	21.5	6	6	40	40	312	312	125	100	-	50	192	10	165	130	200	12
80ML <sup>1)</sup>	19	19	21.5	21.5	6	6	40	40	337	337	125	100	112	50	192	10	165	130	200	12
80ML <sup>2)</sup>	19	19	21.5	21.5	6	6	40	40	367	367	125	100	112	50	192	10	165	130	200	12
90S	24	24	27	27	8	8	50	50	339	339	140	100	-	56	217	10	165	130	200	12
90SL	24	24	27	27	8	8	50	50	390	390	140	100	125	56	217	10	165	130	200	12
100LK	28	28	31	31	8	8	60	60	463	463	160	140	160	63	243	12	215	180	250	14.5
112ML	28	28	31	31	8	8	60	60	480	480	190	140	159	70	264	12	215	180	250	14.5
132S	38	38	41	41	10	10	80	80	510	510	216	140	-	89	307	12	265	230	300	14.5
132SM	38	38	41	41	10	10	80	80	560	560	216	140	178	89	307	12	265	230	300	14.5
160ML <sup>3)</sup>	42	42	45	45	12	12	110	110	626.5	626.5	254	210	254	108	413	14.5	300	250	350	18.5
160ML <sup>4)</sup>	42	42	45	45	12	12	110	110	683.5	683.5	254	210	254	108	413	14.5	300	250	350	18.5
180ML	48	48	51.5	51.5	14	14	110	110	729	729	279	241	279	121	453	14.5	300	250	350	18.5
200ML	55	55	59	59	16	16	110	110	810	810	318	267	305	133	514	18.5	350	300	400	18.5
225SM	55	60	59	64	16	18	110	140	864	894	356	286	311	149	557	18.5	400	350	450	18.5
250SM	60	65	64	69	18	18	140	140	913	913	406	311	349	168	616	24	500	450	550	18.5
280SM <sup>5)</sup>	65	75	69	79.5	18	20	140	140	1182	1182	457	368	419	190	747	24	500	450	550	18.5
280SM <sup>6)</sup>	65	75	69	79.5	18	20	140	140	1052	1052	457	368	419	190	747	24	500	450	550	18.5
315SM	65	80	69	85	18	22	140	170	1216	1246	508	406	457	216	849	28	600	550	560	24
315ML	65	90	69	95	18	25	140	170	1326	1356	508	457	508	216	849	28	600	550	560	24
315LK	-	90	-	95	-	25	-	170	-	1458	508	508	560	216	849	28	600	550	560	24
355SM	70	100	74.5	106	20	28	140	210	1399	1469	610	500	560	254	933	35	740	680	800	24
355ML	70	100	74.5	106	20	28	140	210	1514	1584	610	560	630	254	933	35	740	680	800	24

<sup>1)</sup> MLA 2, MLA 4, MLA 6

<sup>2)</sup> MLB 4, MLB 6

<sup>3)</sup> MLA 2

<sup>4)</sup> MLA 4, MLA 6, MLB 2, MLB 4, MLB 6, MLC 2

<sup>5)</sup> SMB2, SMA4, SMB4, SMB6

<sup>6)</sup> SMA2, SMA6

### IMB14 (IM3601)

Motor size	M	N	P	S
80M	100	80	120	M6
80ML <sup>1)</sup>	100	80	120	M6
80ML <sup>2)</sup>	100	80	120	M6
90S	115	95	140	M8
90SL	115	95	140	M8
100LK	130	110	160	M8
112ML	130	110	160	M8
132S	165	130	200	M10
132SM	165	130	200	M10



# Dimension drawings

## IE3 General performance cast iron motors

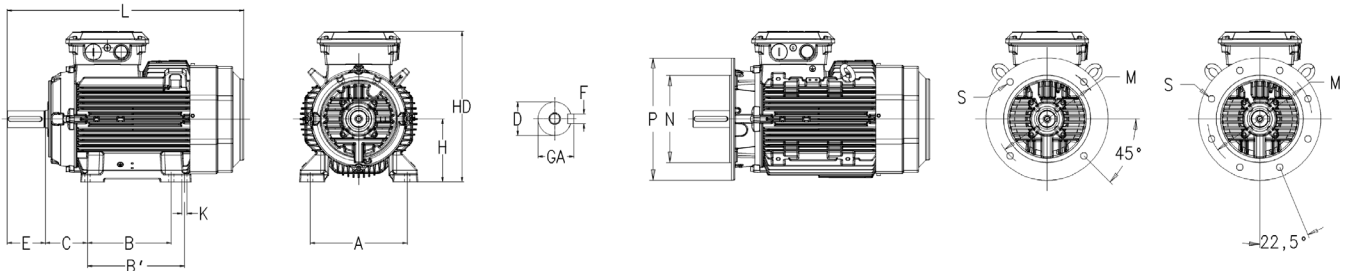

Motor size	IM1001, IMB3 and IM3001, IMB5										IM1001, IMB3				IM B5 (IM3001)					
	D		GA		F		E		L max		A	B	B1	C	HD	K	M	N	P	S
	2	4-8	2	4-8	2	4-8	2	4-8	2	4-8					max					
71M	14	14	16	16	5	5	30	30	257	257	112	90	-	45	175	7	130	110	160	10
71ML	14	14	16	16	5	5	30	30	282	282	112	90	-	45	175	7	130	110	160	10
80M	19	19	21.5	21.5	6	6	40	40	309	309	125	100	-	50	192	10	165	130	200	12
80ML	19	19	21.5	21.5	6	6	40	40	334	334	125	100	112	50	192	10	165	130	200	12
90S	24	24	27	27	8	8	50	50	335	335	140	100	-	56	217	10	165	130	200	12
90SL	24	24	27	27	8	8	50	50	351	351	140	100	125	56	217	10	165	130	200	12
90L_	24	24	27	27	8	8	50	50	386	386	140	125	-	56	217	10	165	130	200	12
100L_	28	28	31	31	8	8	60	60	376	376	160	140	-	63	240	12	215	180	250	14.5
100LK_	28	28	31	31	8	8	60	60	411	411	160	140	160	63	240	12	215	180	250	14.5
112M_	28	28	31	31	8	8	60	60	411	411	190	140	-	70	252	12	215	180	250	14.5
112ML_	28	28	31	31	8	8	60	60	456	456	190	140	159	70	252	12	215	180	250	14.5
132S_	38	38	41	41	10	10	80	80	521	521	216	178	-	89	302	12	265	230	300	14.5
132M_	38	38	41	41	10	10	80	80	586	586	216	178	203	89	302	12	265	230	300	14.5
160 MLA 2	42	42	45	45	12	12	110	110	587	587	254	210	254	108	413	14.5	300	250	350	18.5
160 MLB 2	42	42	45	45	12	12	110	110	587	587	254	210	254	108	413	14.5	300	250	350	18.5
160 MLA 4	42	42	45	45	12	12	110	110	627	627	254	210	254	108	413	14.5	300	250	350	18.5
160 MLA 6	42	42	45	45	12	12	110	110	627	627	254	210	254	108	413	14.5	300	250	350	18.5
160 MLC 2	42	42	45	45	12	12	110	110	684	684	254	210	254	108	413	14.5	300	250	350	18.5
160 MLB 4	42	42	45	45	12	12	110	110	684	684	254	210	254	108	413	14.5	300	250	350	18.5
160 MLB 6	42	42	45	45	12	12	110	110	684	684	254	210	254	108	413	14.5	300	250	350	18.5
180 MLA2	48	48	51.5	51.5	14	14	110	110	684	684	279	241	279	121	434	14.5	300	250	350	18.5
180 MLA4	48	48	51.5	51.5	14	14	110	110	684	684	279	241	279	121	434	14.5	300	250	350	18.5
180 MLA6	48	48	51.5	51.5	14	14	110	110	744	744	279	241	279	121	434	14.5	300	250	350	18.5
180 MLB4	48	48	51.5	51.5	14	14	110	110	744	744	279	241	279	121	434	14.5	300	250	350	18.5
200 MLA6	55	55	59	59	16	16	110	110	728	728	318	267	305	133	473	18.5	350	300	400	18.5
200 MLA2	55	55	59	59	16	16	110	110	828	828	318	267	305	133	473	18.5	350	300	400	18.5
200 MLA4	55	55	59	59	16	16	110	110	828	828	318	267	305	133	473	18.5	350	300	400	18.5
200 MLB2	55	55	59	59	16	16	110	110	828	828	318	267	305	133	473	18.5	350	300	400	18.5
200 MLB6	55	55	59	59	16	16	110	110	828	828	318	267	305	133	473	18.5	350	300	400	18.5
225 SMA2	55	55	59	59	16	16	110	110	854	854	356	286	311	149	539	18.5	400	350	450	18.5
225 SMA4	55	55	59	59	16	16	110	110	812	812	356	286	311	149	539	18.5	400	350	450	18.5
225 SMA6	55	55	59	59	16	16	110	110	812	812	356	286	311	149	539	18.5	400	350	450	18.5
225 SMB4	55	55	59	59	16	16	110	110	812	812	356	286	311	149	539	18.5	400	350	450	18.5
250 SMA2	60	60	64	64	18	18	140	140	882	882	406	311	349	168	585	24	500	450	550	18.5
250 SMA4	60	60	64	64	18	18	140	140	927	927	406	311	349	168	585	24	500	450	550	18.5
250 SMA6	60	60	64	64	18	18	140	140	927	927	406	311	349	168	585	24	500	450	550	18.5
280	65	75	69	79.5	18	20	140	140	1012	1012	457	368	419	190	775	24	500	450	550	18.5
315 SM_	65	80	69	85	18	22	140	170	1216	1246	508	406	457	216	849	28	600	550	660	24
315 ML_	65	90	69	95	18	25	140	170	1326	1356	508	457	508	216	849	28	600	550	660	24
355 SM_	70	100	74.5	106	20	28	140	210	1399	1469	610	500	560	254	933	35	740	680	800	24

IMB14 (IM3601)					
Motor size	M	N	P	S	T
71	85	70	105	6	2.5
80	100	80	120	6	3
90	115	95	140	8	3
100	130	110	160	8	3.5
112	130	110	160	8	3.5
132	165	130	200	10	3.5

# Motors in brief

## IE4 cast iron motors, sizes 80–132

Motor size		80	90	100	112	132
Stator and end shields	Material	Cast iron				
	Paint colour shade	Munsell blue 8B 4.5/3.25				
	Corrosion class	C3 (medium)				
Feet	Material	Integrated cast iron feet				
Bearings	D-end	6204-2Z/C3	6205-2Z/C3	6206-2Z/C3	6207-2Z/C3	6208-2Z/C3
	N-end	6204-2Z/C3	6205-2Z/C3	6206-2Z/C3	6206-2Z/C3	6208-2Z/C3
Axially-locked bearings	Inner bearing cover	Locked at D-end with retaining ring				
Bearing seal	D-end	V-ring				
	N-end	V-ring				
Lubrication		Permanently lubricated shielded bearings				
Measuring nipples for condition monitoring of the bearings		Not Included				
Rating plate	Material	Stainless steel				
Terminal box	Frame material	Cast iron				
	Cover material	Steel				
	Corrosion class	C3 (medium)				
	Cover screws material	Zinc-electroplated steel				
Connections	Threaded openings	2xM25, 1xM16		2xM32, 1xM16		
	Max Cu-area mm	6			10	
	Terminals	6 terminals for connection with cable lugs				
	Cable glands	Cable glands as option				
Fan	Material	Glass-fiber reinforced polypropylene				
Fan cover	Material	Steel				
	Paint colour shade	Munsell blue 8B 4.5/3.25				
	Corrosion class	C3 (medium)				
Stator winding	Material	Copper				
	Insulation	Insulation class F. Temperature rise class B unless otherwise stated				
	Winding protection	3 PTC thermistors, 150°C				
Rotor winding	Material	Pressure die-cast aluminum				
Balancing		Half-key balancing as standard				
Key ways		Open keyway				
Drain holes		Drain holes with closable plastic plugs, open on delivery				
External earthing bolt		M5				
Enclosure		IP 55 Higher protection on request				
Cooling method		IC 411				
Lifting lug		NA	Integrated cast iron lifting lugs			

# Motors in brief

## IE4 cast iron motors, sizes 160–250

Motor size		160	180	200	225	250
Stator and end shields	Material	Cast iron				
	Paint colour shade	Munsell blue 8B 4.5/3.25				
	Corrosion class	C3 (medium)				
Feet	Material	Integrated cast iron feet				
Bearings	D-end	6309-2Z/C3	6310-2Z/C3	6312-2Z/C3	6313-2Z/C3	6315-2Z/C3
	N-end	6209-2Z/C3	6210-2Z/C3	6212-2Z/C3	6213-2Z/C3	6215-2Z/C3
Axially-locked bearings	Inner bearing cover	Locked at D-end with inner bearing cover				
Bearing seal	D-end	V-ring				
	N-end	V-ring				
Lubrication		Permanently lubricated shielded bearings				
Measuring nipples for condition monitoring of the bearings		Not Included				
Rating plate	Material	Stainless steel				
Terminal box	Frame material	Steel				
	Cover material	Steel				
	Corrosion class	C3 (medium)				
	Cover screws material	Zinc-electroplated steel				
Connections	Threaded openings	2xM40, 1xM16		1xM16, 2xM63		
	Max Cu-area mm	35		70		
	Terminals	6 terminals for connection with cable lugs				
	Cable glands	Cable glands as option				
Fan	Material	Glass-fiber reinforced polypropylene				
Fan cover	Material	Steel				
	Paint colour shade	Munsell blue 8B 4.5/3.25				
	Corrosion class	C3 (medium)				
Stator winding	Material	Copper				
	Insulation	Insulation class F. Temperature rise class B unless otherwise stated				
	Winding protection	3 PTC thermistors, 150°C				
Rotor winding	Material	Pressure die-cast aluminum				
Balancing		Half-key balancing as standard				
Key ways		Open keyway				
Drain holes		Drain holes with closable plastic plugs, open on delivery				
External earthing bolt		M6				
Enclosure		IP 55 Higher protection on request				
Cooling method		IC 411				
Lifting lug		Integrated cast iron lifting lugs				

# Motors in brief

## IE4 cast iron motors, sizes 280–355

Motor size		280	315	355
Stator and end shields	Material	Cast iron		
	Paint colour shade	Munsell blue 8B 4.5/3.25		
	Corrosion class	C3 (medium)		
Feet	Material	Integrated cast iron feet		
Bearings	D-end	6316/C3	6316/C3 (2P) 6319/C3 (4-8P)	6316/C3 (2P) 6322/C3 (4-8P)
	N-end	6316/C3	6316/C3	6316/C3
Axially-locked bearings	Inner bearing cover	Locked at D-end with inner bearing cover		
Bearing seal	D-end	V-ring		
	N-end	V-ring		
Lubrication		Regreasable bearings		
Measuring nipples for condition monitoring of the bearings		Not included		
Rating plate	Material	Stainless steel		
Terminal box	Frame material	Cast iron		
	Cover material	Cast iron		
	Corrosion class	C3 (medium)		
	Cover screws material	Zinc-electroplated steel		
Connections	Threaded openings	2xM20, 2xM63	2xM20, 2xM63	2xM75, 2xM20
	Max Cu-area mm	2x150	2x240	4x240
	Terminals	6 terminals for connection with cable lugs		
	Cable glands	Cable glands as option		
Fan	Material	Glass-fiber reinforced polypropylene or Aluminium		
Fan cover	Material	Steel		
	Paint colour shade	Munsell blue 8B 4.5/3.25		
	Corrosion class	C3 (medium)		
Stator winding	Material	Copper		
	Insulation	Insulation class F. Temperature rise class B unless otherwise stated		
	Winding protection	3 PTC thermistors, 150°C		
Rotor winding	Material	Pressure die-cast aluminum		
Balancing		Half-key balancing as standard		
Key ways		Open keyway		
Drain holes		Drain holes with closable plastic plugs, open on delivery		
External earthing bolt		M10		
Enclosure		IP 55 Higher protection on request		
Cooling method		IC 411		
Lifting lug		Bolted lifting lugs		

# Motors in brief

## IE3 cast iron motors, sizes 71–112

Motor size	M2BAX	71	80	90	100	112
Stator and end shields	Material	Cast iron				
	Paint color shade	Munsell blue 8B 4.5/3.25				
	Corrosion class	C3				
Feet	Material	Integrated cast iron				
Bearings	D-end	6203-2Z/C3	6204-2Z/C3	6205-2Z/C3	6206-2Z/C3	6206-2Z/C3
	N-end	6202-2Z/C3	6203-2Z/C3	6204-2Z/C3	6205-2Z/C3	6205-2Z/C3
Axially locked bearings		Locked at D-end with retaining ring				
Bearing seals	D-end	V-ring				
	N-end	V-ring				
Lubrication		Permanently lubricated shielded bearings				
Measuring nipples for condition monitoring of the bearings		Not Included				
Rating plate	Material	Stainless steel				
Terminal box	Material	Steel				
	Corrosion class	C3				
	Cover screws	Zinc-electroplated steel				
Connections	Threaded openings	2xM16	2xM25	2xM32		
	Max Cu-area mm	4	6	10		
	Terminals	6 terminals for connection with cable lugs (not included)				
	Cable glands	Glands as option				
	Fan	Material	Glass-fiber reinforced polypropylene			
Fan cover	Material	Steel				
	Paint color shade	Munsell blue 8B 4.5/3.25				
	Corrosion class	C3				
Stator winding	Material	Copper				
	Insulation	Insulation class F. Temperature rise class B unless otherwise stated.				
	Winding protection	3 PTC thermistors, 150°C				
Rotor winding	Material	Pressure die-cast aluminum				
Balancing method		Half key balancing as standard				
Key ways		Open key way				
Drain holes		Drain holes with closable plastic plugs, open on delivery				
Enclosure		IP 55 Higher protection on request				
Cooling method		IC 411				
Lifting lugs		Integrated cast iron lifting lugs				

# Motors in brief

## IE3 cast iron motors, sizes 132–250

Motor size	M2BAX	132	160	180	200	225	250
Stator and end shields	Material	Cast iron					
	Paint color shade	Munsell blue 8B 4.5/3.25					
	Corrosion class	C3					
Feet	Material	Integrated cast iron feet					
Bearings	D-end	6208-2Z/C3	6209-2Z/C3	6210-2Z/C3	6212/C3	6213-2Z/C3	6215-2Z/C3
	N-end	6208-2Z/C3	6209-2Z/C3	6209-2Z/C3	6209-2Z/C3	6210-2Z/C3	6212-2Z/C3
Axially locked bearings		Locked at D-end with retaining ring		Locked at D-end with inner bearing cover			
Bearing seals	D-end	V-ring					
	N-end	V-ring					
Lubrication		Permanently lubricated shielded bearings					
Measuring nipples for condition monitoring of the bearings		Not Included					
Rating plate	Material	Stainless steel					
Terminal box	Material	Steel					
	Corrosion class	C3					
	Cover screws	Zinc-electroplated steel					
Connections	Threaded openings	2xM32	2xM40, 1xM16	1xM16, 2xM63			
	Terminals	6 terminals for connection with cable lugs (not included)					
	Cable glands	Glands as option	Cable flange included, glands as option				
Fan	Material	Glass-fiber reinforced polypropylene					
Fan cover	Material	Steel					
	Paint color shade	Munsell blue 8B 4.5/3.25					
	Corrosion class	C3					
Stator winding	Material	Copper					
	Insulation	Insulation class F. Temperature rise class B unless otherwise stated.					
	Winding protection	3 PTC thermistors, 150 °C					
Rotor winding	Material	Pressure die-cast aluminum					
Balancing method		Half-key balancing as standard					
Key ways		Open key way					
Drain holes		Drain holes with closable plastic plugs, open on delivery					
Enclosure		IP 55 Higher protection on request					
Cooling method		IC 411					
Lifting lugs		Integrated cast iron lifting lug					

# Motors in brief

## IE3 cast iron motors, sizes 280–355

Motor size	M2BAX	280	315	355
Stator and end shields	Material	Cast iron		
	Paint color shade	Munsell blue 8B 4.5/3.25		
	Corrosion class	C3		
Feet	Material	Integrated cast iron		
Bearings	D-end, 2 pole	6316/C3	6217/C3	6316/C3
	D-end, 4-6 pole	6316/C3	6219/C3	6316/C3
	N-end, 2-pole	6316/C3	6217/C3	6217/C3
	N-end, 4-6 pole	6316/C3	6217/C3	6217/C3
Axially locked bearings		Locked at D-end with inner bearing cover		
Bearing seals	D-end	V-ring		
	N-end	V-ring		
Lubrication		Regreasable bearings, regreasing nipples M6x1		
Measuring nipples for condition monitoring of the bearings		Not included		
Rating plate	Material	Stainless steel		
Terminal box	Material	Cast iron		
	Cover	Cast iron terminal box cover		
	Corrosion class	C3		
	Cover screws	Zinc-electroplated steel		
	Threaded openings	2 x M20, 2xM63		2xM75, 2 x M20
Connections	Terminals	6 terminals for connection with cable lugs (not included)		
	Cable glands	Cable glands as option		
Fan	Material	Glass-fiber reinforced polypypropylene / 2-pole metal.		
Fan cover	Material	Steel fan cover		
	Paint color shade	Black / Munsell blue 8B 4.5/3.25		
	Corrosion class	C3		
Stator winding	Material	Copper		
	Insulation	Insulation class F. Temperature rise class B unless otherwise stated.		
	Winding protection	3 PTC thermistors, 150 °C		
Rotor winding	Material	Pressure diecast aluminum		
Balancing method		Half key balancing as standard		
Keyway		Open key way	2x60 W	
Heating elements		60 W		
Enclosure		IP 55 Higher protection on request		
Cooling method		IC 411		
Drain holes		Drain holes with closable plastic plugs, open on delivery		
Lifting lugs		Bolted lifting lugs		

# Total product offering

Motors and generators with a complete portfolio of services



## IEC motors

- Low voltage motors
- High voltage induction and synchronous motors
- Marine motors
- Motors for explosive atmospheres
- Motors for food and beverage
- Motors for variable speed drives
- Permanent magnet motors
- Synchronous reluctance motors
- Traction motors

## NEMA motors

- Low voltage motors
- High voltage induction and synchronous motors
- Marine motors
- Motors for explosive atmospheres
- Motors for variable speed drives
- Permanent magnet motors
- Servomotors
- Washdown motors

## Generators

- Generators for wind turbines
- Generators for diesel and gas engine power plants
- Generators for steam and gas turbine power plants
- Generators for marine applications
- Generators for industrial applications
- Generators for traction applications
- Synchronous condensers for reactive power compensation

## Life cycle services



# ABB's portfolio of drives

## Optimal solution for you



Being able to rely on the continuous high performance and efficiency of your operations is something you want to take for granted. ABB variable-frequency drives are made with all this in mind, established upon more than 40 years of experience and backed by a broad range of life cycle services.

ABB drives help you to optimize your processes and systems with state-of-the-art motor control technology, resulting in increased energy efficiency, better product quality, and reduced operating costs with higher output, less downtime, and reduced need for maintenance. All ABB drives are designed for easy selection, ordering, installation and use, and they offer integrated safety features, giving you more time to focus on what matters for you and your business.

Our portfolio offers low-voltage AC and DC drives, medium-voltage AC drives, and motion control drives spanning the fractional-kilowatt to multi-megawatt power level. There is a drive available for essentially every industry and application and for all types of motors, in environments ranging from water utility facilities to clean electrical rooms, and to harsh coal mines and windy offshore platforms to food and beverage production. This wide product range allows you to select the best-fitting drive solution, providing maximum reliability and efficiency for every need.

**Additional information**

We reserve the right to make technical changes or modify the contents of this document without prior notice. With regard to purchase orders, the agreed particulars shall prevail. ABB does not accept any responsibility whatsoever for potential errors or possible lack of information in this document.

We reserve all rights in this document and in the subject matter and illustrations contained therein. Any reproduction, disclosure to third parties or utilization of its contents – in whole or in parts – is forbidden without prior written consent of ABB.



—  
For more information and contact details:

**[new.abb.com/motors-generators](https://new.abb.com/motors-generators)**