

NM, NMD

Close Coupled Centrifugal Pumps with threaded ports

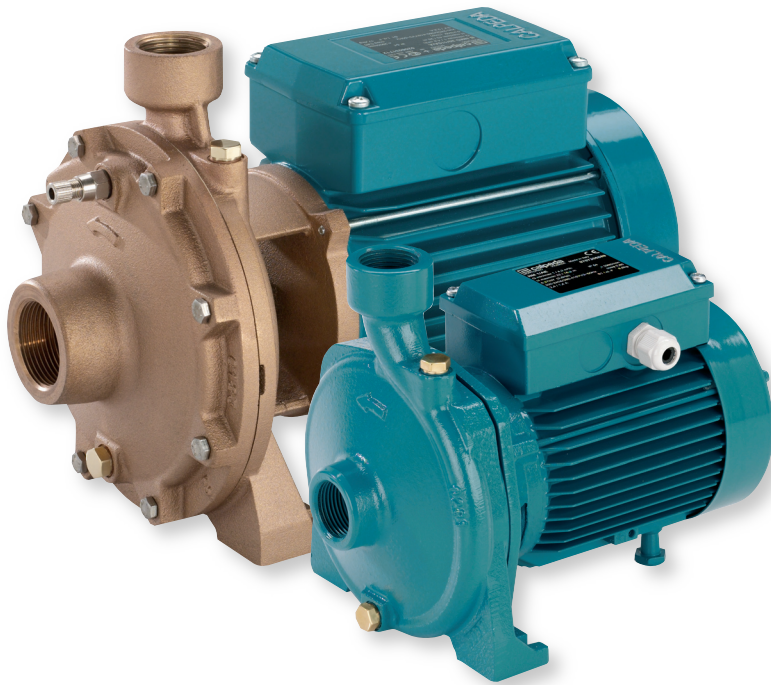

The electropumps NM, B-NM series comply with the European Regulation no. 547/2012.

Materials

Components	NM, NMD	B-NM, B-NMD
Pump casing Lantern bracket	Cast iron GJL 200 EN 1561	Bronze CC480K EN 1982
Impeller	Brass CW617N EN 12165	
	NM 17	
	Cast iron GJL 200 EN 1561	Bronze CC480K EN 1982
Shaft	Cr steel AISI 430 Cr Ni steel AISI 303 1,1 -1,5 - 2,2 kW	Cr Ni Mo steel AISI 316
	NM 6	
Mechanical seal	Carbon - Ceramic - NBR	

Construction

Close-coupled, centrifugal pumps; electric motor with extended shaft directly connected to the pump.

NM: single-impeller

NMD: with two back-to-back impellers (with axial thrust balancing).

Connections: threaded ports ISO 228/1 (BS 2779).

NM, NMD: version with pump casing and lantern bracket in cast iron.

B-NM, B-NMD: version with pump casing and lantern bracket in bronze.
(the pumps are supplied fully painted).

Applications

For clean liquids without abrasives, which are non-aggressive for the pump materials (solids content up to 0.2%).

For water supply.

For heating, air-conditioning, cooling and circulation plants.

For civil and industrial applications.

For fire fighting applications. For irrigation.

Operating conditions

Liquid temperature from -10 °C to +90 °C.

Ambient temperature up to 40° C.

Total suction lift up to 7 m.

Maximum permissible working pressure up to 10 bar

(16 bar for pumps NMD 25/190; NMD 32/210; NMD 40/180).

Continuous duty (S3 60% for 1,5-1,8 kW)

Motor

2-pole induction motor, 50 Hz ($n \approx 2900$ rpm).

NM, NMD: three-phase 230/400 V $\pm 10\%$ up to 3 kW;

400/690 V $\pm 10\%$ from 4 to 9,2 kW;

NMM, NMDM: single-phase 230 V $\pm 10\%$, with thermal protector.

Insulation class F. Protection IP 54.

Motor suitable for operation with frequency converter from 1,1 kW.

IE2 efficiency class for single-phase motors up to 1,1 kW.

IE3 efficiency class for three-phase motors (IE2 up to 0,65 kW).

Constructed in accordance with EN 60034-1; EN 60034-30-1.

EN 60335-1, EN 60335-2-41.

Special features on request

- Other voltages. - Frequency 60 Hz (as per 60 Hz data sheet).

- Protection IP 55. - Special mechanical seal

- Higher or lower liquid or ambient temperatures.

- Motor suitable for operation with frequency converter up to 0,75 kW.

Coverage chart $n \approx 2900$ rpm

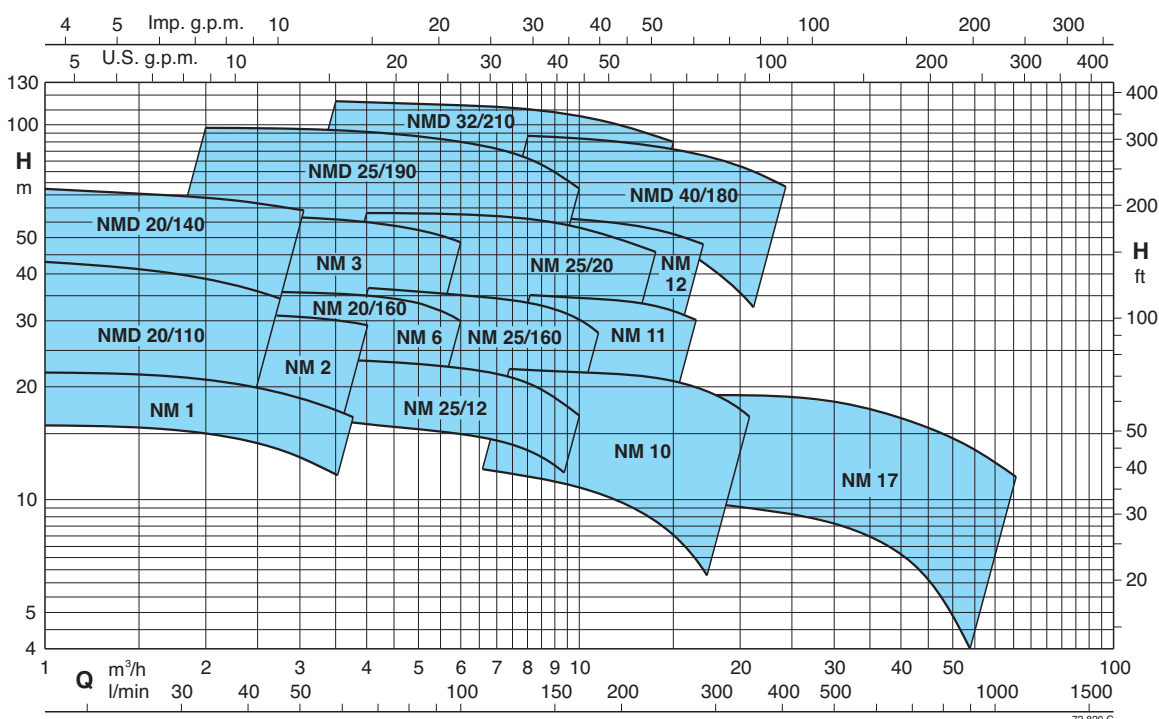

Performance n ≈ 2900 rpm

	NM	P ₂		Q m³/h l/min	1	1,2	1,5	1,89	2,4	3	3,6	4,2	4,8	5,4	6	6,6	7,5	8,4
		kW	HP		16	20	25	31,5	40	50	60	70	80	90	100	110	125	140
		H m																
	NM 1/AE●	0,37	0,5	22	21,6	21,3	20,9	20,3	19,4	18,1	16,3							
	NM 2/B/A●	0,55	0,75	27	26,5	26	25,5	25	24	23	22	20						
	NM 2/S/A●	0,55	0,75	31	30,5	30	29	27,5	25,5	23,5	20	16						
	NM 2/A/B●	0,75	1	33,5	33	32,5	32	31,5	30,5	29,5	28,5	27	26	24				
	NM 6/B●	0,75	1				30,5	30	29,5	28,5	27,5	26,5	25,5	24	22	18		
	NM 6/A●	1,1	1,5				35,5	35,2	34,7	34	33	32	30,5	29	27	23,5	19*	
	NMM 3/CE	1,1	1,5		37,5	37,5	37	36,5	36	35	34	32						
	NM 3/C/A	1,1	1,5		37,5	37,5	37	36,5	36	35	34	32	30,5	28,5				
	NMM 3/BE	1,5	2		42	42	41,5	41	40,5	40	39	37	35	32				
	NM 3/B/A	1,5	2		47	47	46,5	46	45,5	45	44	43	41,5	40	37,5	33	26	
	NMM 3/A/A	1,8	2,5		47,5	47,5	47	46,5	46	45,5	44,5	43,5	42	40,5	38	33,5	26,5	
	NM 3/A/B	2,2	3		56	55,5	55,5	55	54,5	53,5	52,5	51,5	50	48	46	42	36	

B-NM B-NMD	NM NMD	P ₂		Q m³/h l/min	1	1,2	1,5	1,89	2,4	3	3,6	4,2	4,8	5,4	6	6,6	7,5	8,4
		kW	HP		16	20	25	31,5	40	50	60	70	80	90	100	110	125	140
		H m																
B-NMD 20/110B/A●	NMD 20/110B/A●	0,45	0,6	33	32	31	29	26,5	23	18								
B-NMD 20/110Z/A●	NMD 20/110Z/A●	0,55	0,75	37	36	35	33	30,5	27,5	23	18							
B-NMD 20/110A/B●	NMD 20/110A/B●	0,75	1	43	42	40,5	39	36,5	33	29	25							
B-NMDM 20/140BE	NMDM 20/140BE	1,1	1,5	52	51,5	51	50	48,5	47	45								
B-NMD 20/140B/A	NMD 20/140B/A	1,1	1,5	53	52,5	52	51	50	48	46	43,5	40						
B-NMDM 20/140AE	NMDM 20/140AE	1,5	2	57,5	57	56,5	55,5	54	51,5	49	46	43	40	36				
B-NMD 20/140A/A	NMD 20/140A/A	1,5	2	67	66,5	66	64,5	63	61,5	59	57	53,5	50	46				
B-NM 20/160BE●	NM 20/160BE●	0,75	1				30,5	30	29,5	28,5	27,5	26,5	25,5	24	22			
B-NM 20/160A/A●	NM 20/160A/A●	1,1	1,5				36	35,5	35	34,5	33,5	32	30,5	29	27			

B-NM B-NMD	NM NMD	P ₂		Q m³/h l/min	2,4	3	3,6	4,8	6	6,6	7,5	8,4	9,6	10,8	12	13,2	15	16,8	18
		kW	HP		40	50	60	80	100	110	125	140	160	180	200	220	250	280	300
		H m																	
B-NM 25/12B/A●	NM 25/12B/A●	0,55	0,75	20	19,9	19,8	19,3	18,5	18	17,3	16,3	15	13,2	11					
B-NM 25/12A/B●	NM 25/12A/B●	0,75	1	23,5	23,4	23,3	22,9	22,1	21,7	20,9	20	18,7	17,1	15,2					
B-NM 25/160B/A●	NM 25/160B/A●	1,1	1,5		31	30,7	30	28,5	28	27	26	23							
B-NM 25/160A/A●	NM 25/160A/A●	1,5	2		36,5	36,2	35,5	34,5	34	33,5	32,5	31	28,5	26					
B-NM 25/200B/C	NM 25/20B/C	2,2	3		42,2	41,9	41,4	40,7	40,2	39,7	39	37,9	36,7	35,2	33,4				
B-NM 25/200A/B	NM 25/20A/B	3	4		49,9	49,8	49,4	48,9	48,5	48,1	47,5	46,6	45,6	44,4	43	40,8	37,9		
B-NM 25/200S/C	NM 25/20S/C	4	5,5		57,4	57,3	57	56,8	56,5	56,2	55,8	55,1	54,3	53,2	52	49,9	47,2	44,9	
B-NMD 25/190C/B	NMD 25/190C/B	2,2	3	62	60,5	59	55,5	51	48,5	44	38								
B-NMD 25/190B/A	NMD 25/190B/A	3	4	76	75	74	70	66	64	60	54	46							
B-NMD 25/190A/B	NMD 25/190A/B	4	5,5	98	97	96	93,5	90	88	84	79	70							

	NM	P ₂		Q m³/h l/min	6,6	7,5	8,4	9,6	10,8	12	13,2	15	16,8	18,9	21	24	27	30
		kW	HP		110	125	140	160	180	200	220	250	280	315	350	400	450	500
		H m																
	NM 10/FE●	0,55	0,75	12,5	12,5	12	11,5	11	10	9	7,5							
	NM 10/DE●	0,75	1	18	18	17,5	17	16,5	16	15,5	14							
	NM 10/A/A●	1,1	1,5	23	23	22,5	22	21,5	21	20,5	19							
	NM 10/S/A●	1,5	2	23,5	23,5	23	22,5	22	21,5	21	20,5	19	18,5	16,5	13			
	NMM 11/BE	1,5	2	26,5	25,5	25	24	23	22,5	21,5	19,5	17,5						
	NM 11/B/A	1,5	2	29,5	29,5	29	28,5	27,5	27	26	25*	22,5*						
	NMM 11/A	1,8	2,5	30,2	30,1	29,8	29,4	28,8	28,1	27,4	26	24,5						
	NM 11/A/B	2,2	3	35,5	35,5	35	34,5	34	33,5	33	32*	30*						
	NM 12/D/B	2,2	3	38	37,5	37	36	35	33,5	32								
	NM 12/C/A	3	4	45	44,5	44	43,5	42,5	41	40	38	36						
	NM 12/A/B	4	5,5	57,5	57	56	55,5	55	54,5	53,5	51,5	49						

Performance $n \approx 2900$ rpm

B-NMD	NMD	P ₂		Q m ³ /h l/min	5,4	6	6,6	7,5	8,4	9,6	10,8	12	13,2	15	16,8	18,9	21	24	
		kW	HP		90	100	110	125	140	160	180	200	220	250	280	315	350	400	
B-NMD 32/210D/B	NMD 32/210D/B	4	5,5	H m	71	69	67,5	65	62,5	58	53	46	37*						
B-NMD 32/210C/A	NMD 32/210C/A	5,5	7,5		84	83	82	81	79	76	73	69	64*	54*					
B-NMD 32/210B/A	NMD 32/210B/A	7,5	10		104	103	102	100	98	95	92	88	84*	76*					
B-NMD 32/210A/B	NMD 32/210A/B	9,2	12,5		114	113	112	110	108	105	103	99	96*	90*					
B-NMD 40/180D/B	NMD 40/180D/B	4	5,5					60	59,5	57	56	53	51,5	48	44	39	34*	25*	
B-NMD 40/180C/A	NMD 40/180C/A	5,5	7,5					69	68	67	66	64,5	63	60	57	53	48*	40*	
B-NMD 40/180B/A	NMD 40/180B/A	7,5	10					87	86	85	84	82,5	81	78	75	71	66*	59*	
B-NMD 40/180A/B	NMD 40/180A/B	9,2	12,5					94	93	92	91	89,5	88	85	82	78	74*	67*	

B-NM	NM	P ₂		Q m ³ /h l/min	21	24	27	30	33	37,8	42	48	54	60	66	75	84	96
		kW	HP		350	400	450	500	550	630	700	800	900	1000	1100	1250	1400	1600
B-NM 17/H/A●	NM 17/H/A●	1,1	1,5	H m	9,5	9,2	9	8,6	8,2	7,5	6,7	5,5	3,5*					
B-NM 17/G/A●	NM 17/G/A●	1,5	2		12	11,7	11,5	11,2	11	10,3	9,7	8,5	7*	4*				
B-NM 17/F/B	NM 17/F/B	2,2	3			16	16	15,5	15	14,5	14	13	11,5*	10*	8*			
B-NM 17/D/A	NM 17/D/A	3	4					18	18	17,5	17	16,5	15,5	14*	13*	11,5*		

NM, NMD Standard construction.
B-NM, B-NMD Bronze construction.

P₂ Rated motor power output.
H Total head in m.

● With single-phase motor = NMM - NMDM.
* Maximum suction lift 1-2 m.
Tolerances according to UNI EN ISO 9906:2012

Rated currents

	P ₁		P ₂		230 V 1~	
	kW	kW	HP	IN A	IA/IN	IA/IN
	0,62	0,37	0,5	3	2,7	
	0,72	0,45	0,6	3,6	2,9	
	1	0,55	0,75	4,5	2,3	
* NMM 25/12B/A	0,9	0,55	0,75	4,2	2,5	
* NMM 10/FE	0,9	0,55	0,75	4,2	2,5	
	1,3	0,75	1	6	3	
* NMM 25/12A/A	1,2	0,75	1	5,4	3,3	
* NMm 10/DE	1,2	0,75	1	5,8	2,6	
	1,6	1,1	1,5	7,4	3	
	2	1,5	2	9,2	3,8	
	2,5	1,8	2,5	11,2	4,5	

	P ₂		230 V Δ / 400 V Y 400 V Δ / 690 V Y			IA/IN
	kW	HP	IN A	IN A	IN A	
	0,37	0,5	2,3	1,3		3,8
	0,45	0,6	2,3	1,3		3,5
	0,55	0,75	3	1,7		3,6
* NM 25/12B/A	0,55	0,75	2,8	1,6		3,9
* NM 10/FE	0,55	0,75	4	2,3		4,8
	0,75	1	3,7	2,2		5,5
* NM 25/12A/B	0,75	1	3,5	2		6,1
* NM 10/DE	0,75	1	4	2,3		6,1
	1,1	1,5	4,6	2,7		5,5
	1,5	2	7,5	4,3		6,1
	2,2	3	9,2	5,3		8,4
* NM 25/20B/C	2,2	3	9,6	5,5		8,1
	3	4	11,5	6,6		8,2
	4	5,5		9,6	5,5	8,9
	5,5	7,5		10,9	6,3	9,1
	7,5	10		14,3	8,3	9,1
	9,2	12,5		18,5	10,7	8,2

P₁ Maximum power input.
P₂ Rated motor power output.
IA/IN D.O.L. starting current / Nominal current

Characteristic curves $n \approx 2900$ rpm

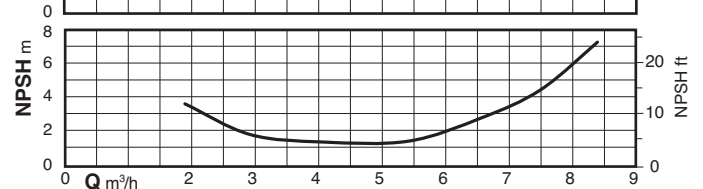
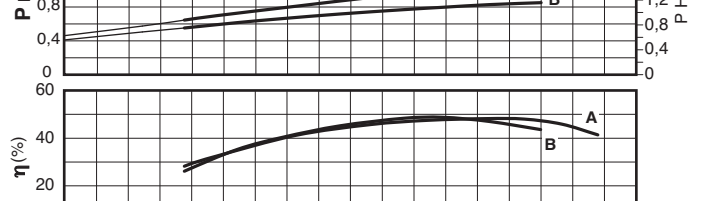
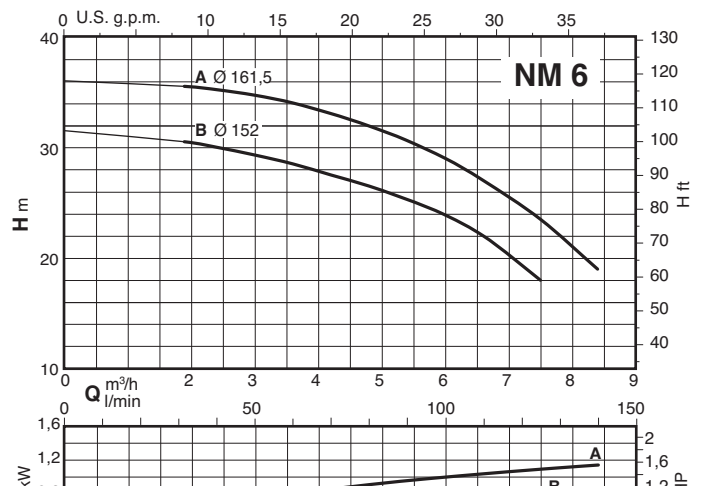
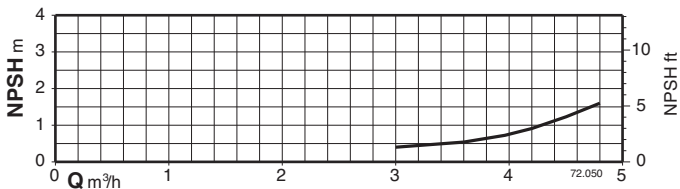
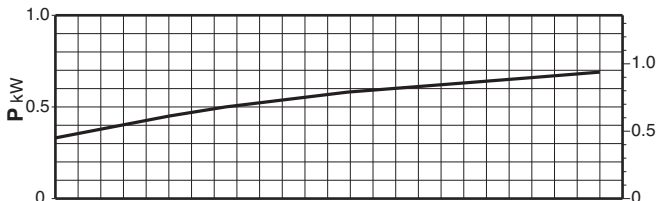
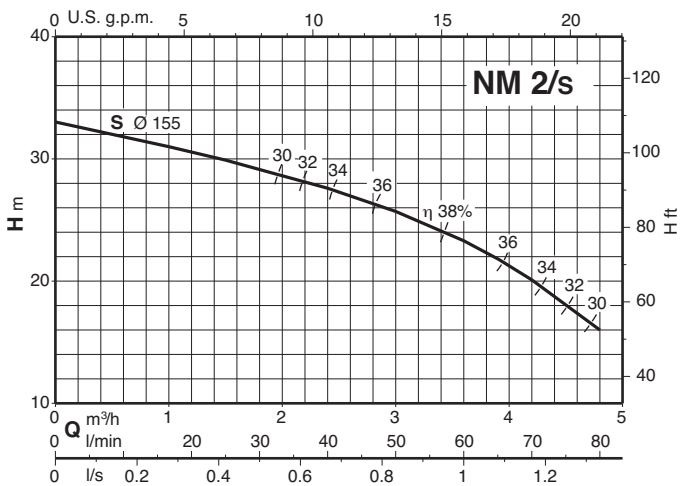
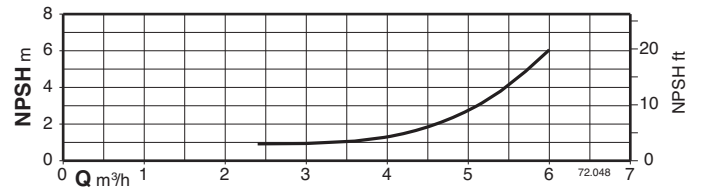
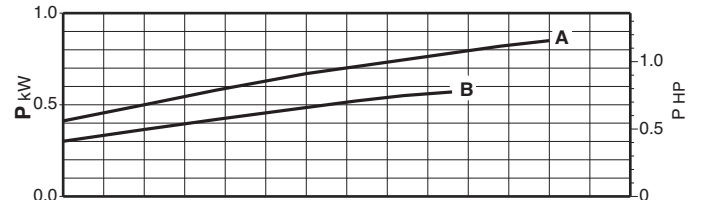
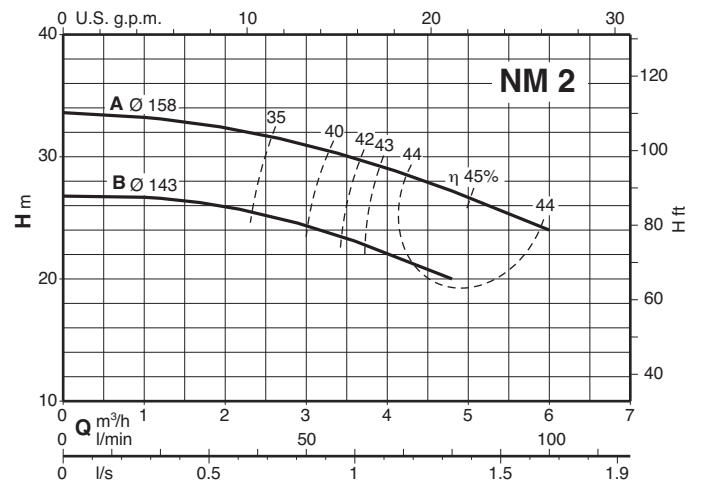
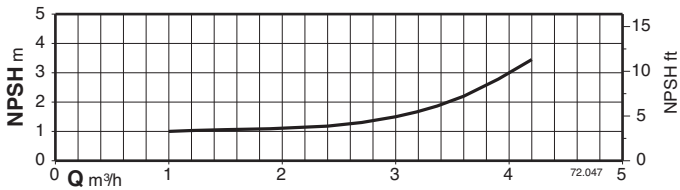
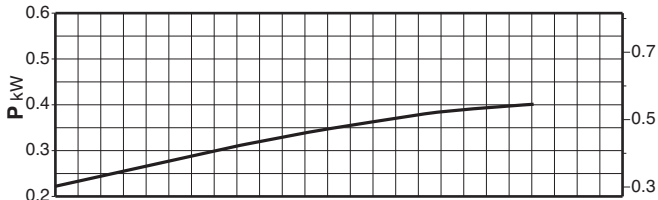
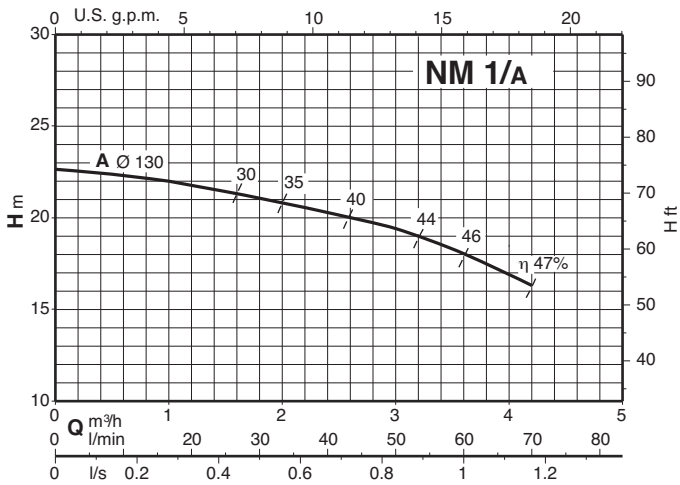

Characteristic curves $n \approx 2900$ rpm

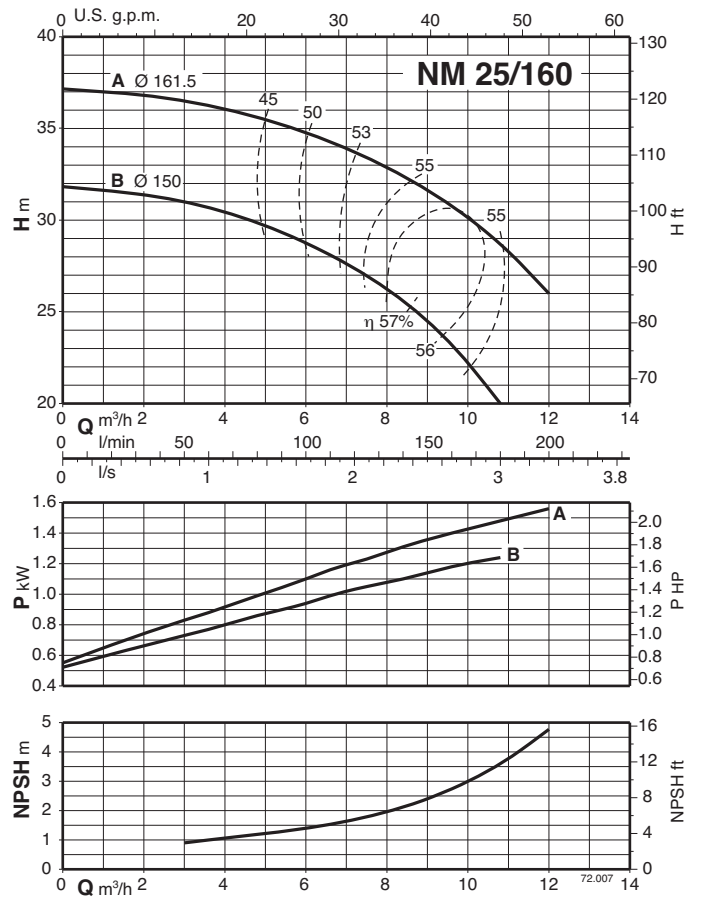
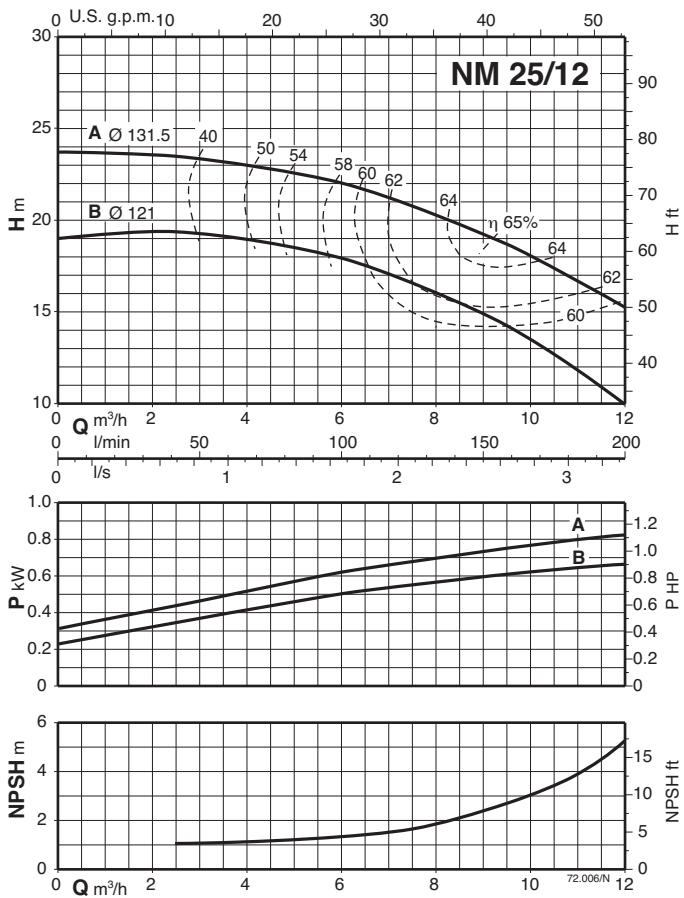
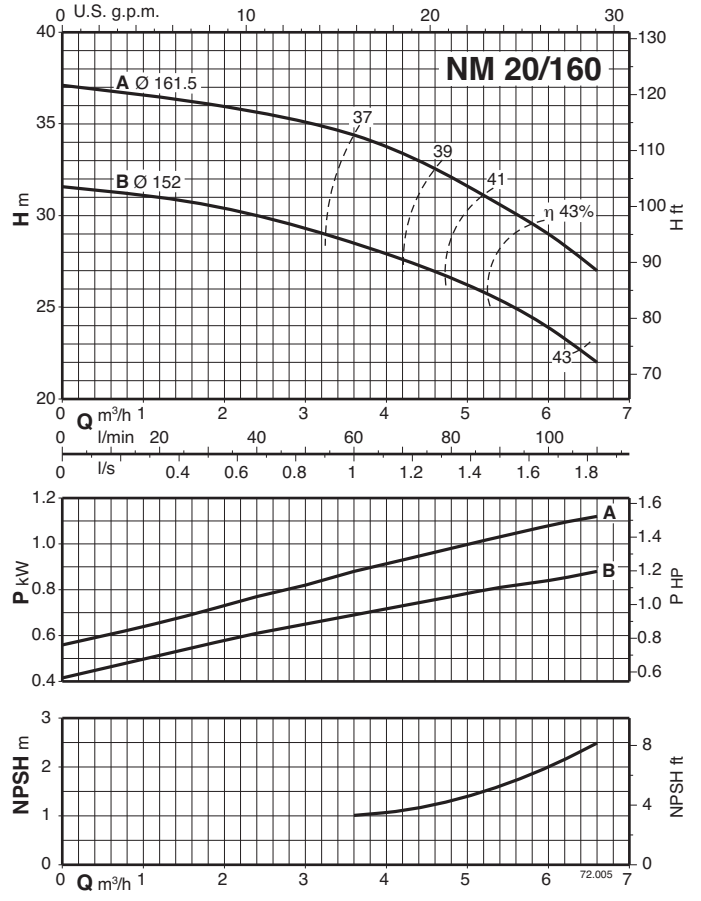
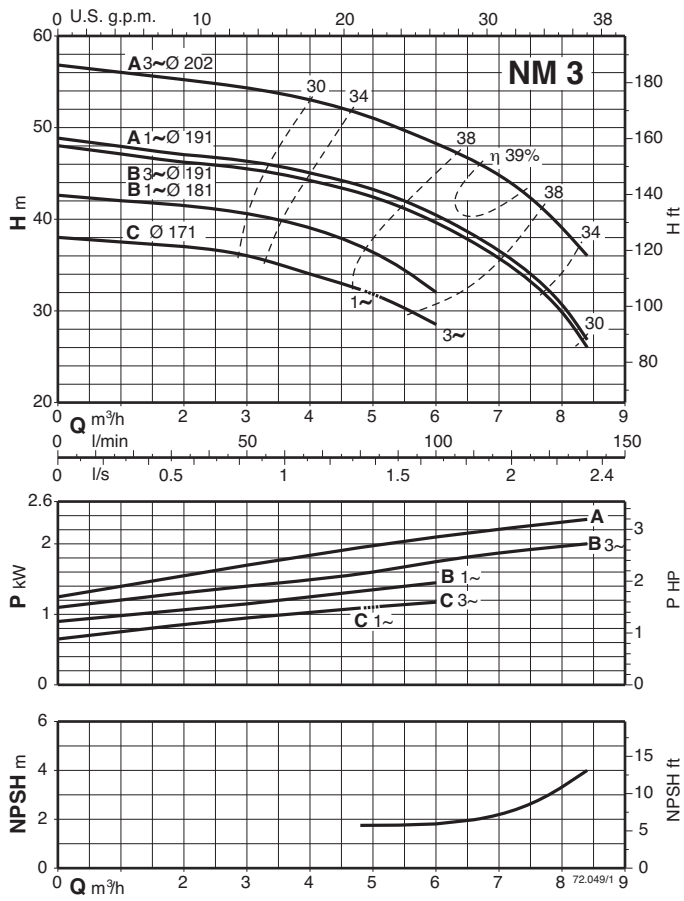

Characteristic curves $n \approx 2900$ rpm

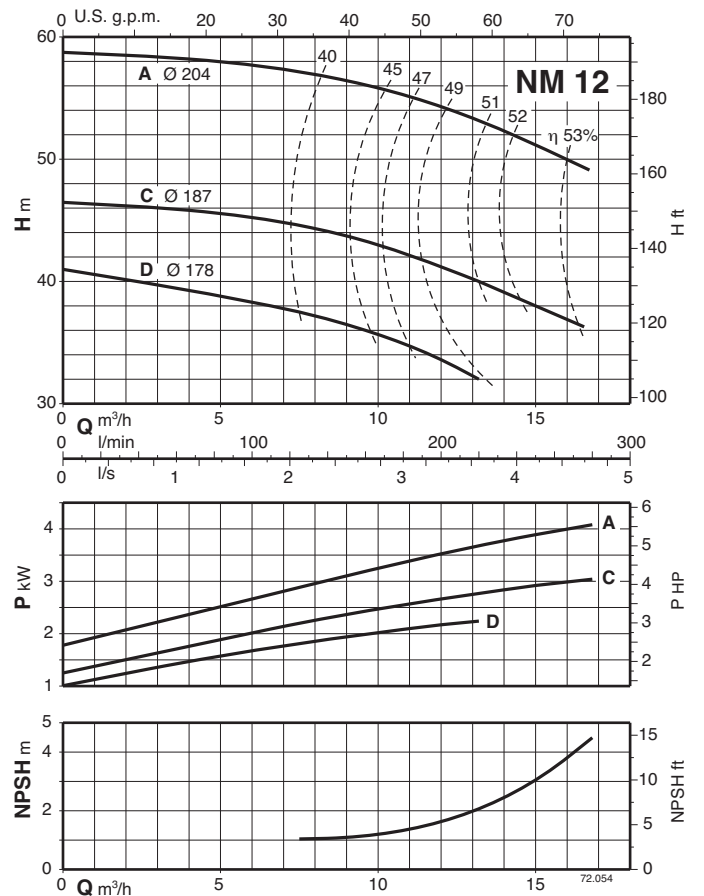
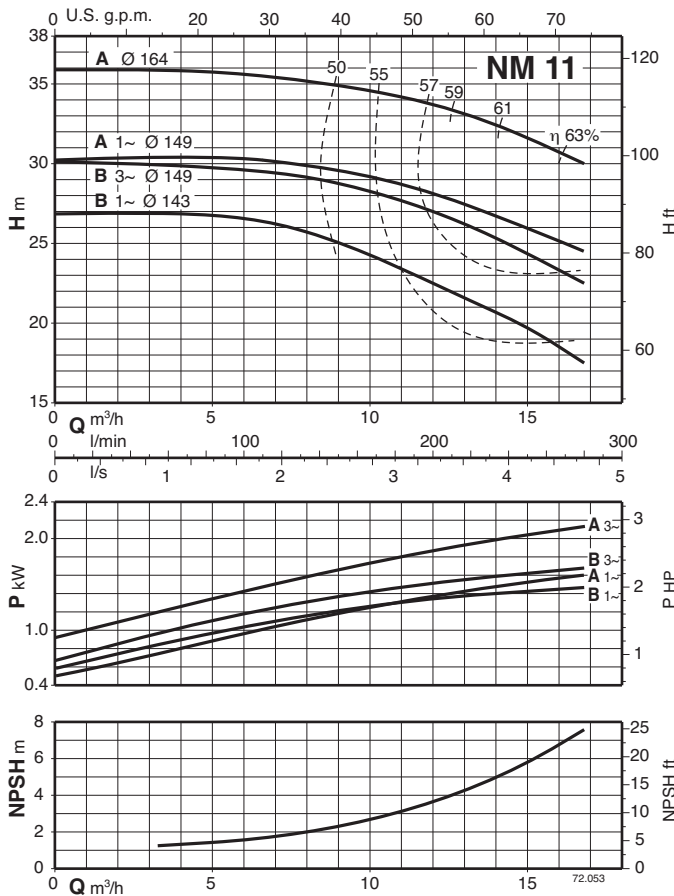
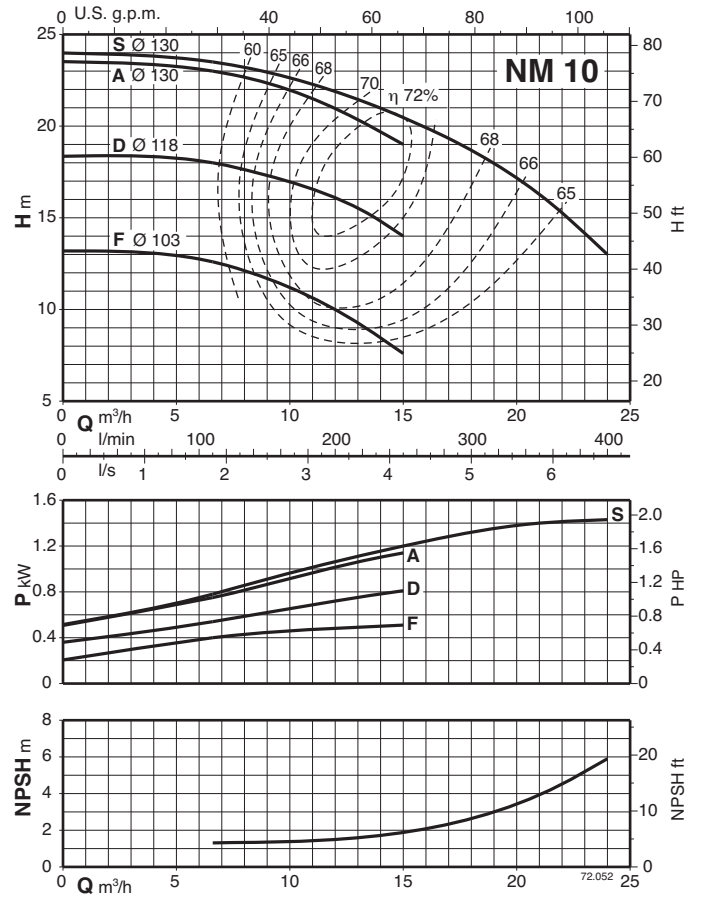
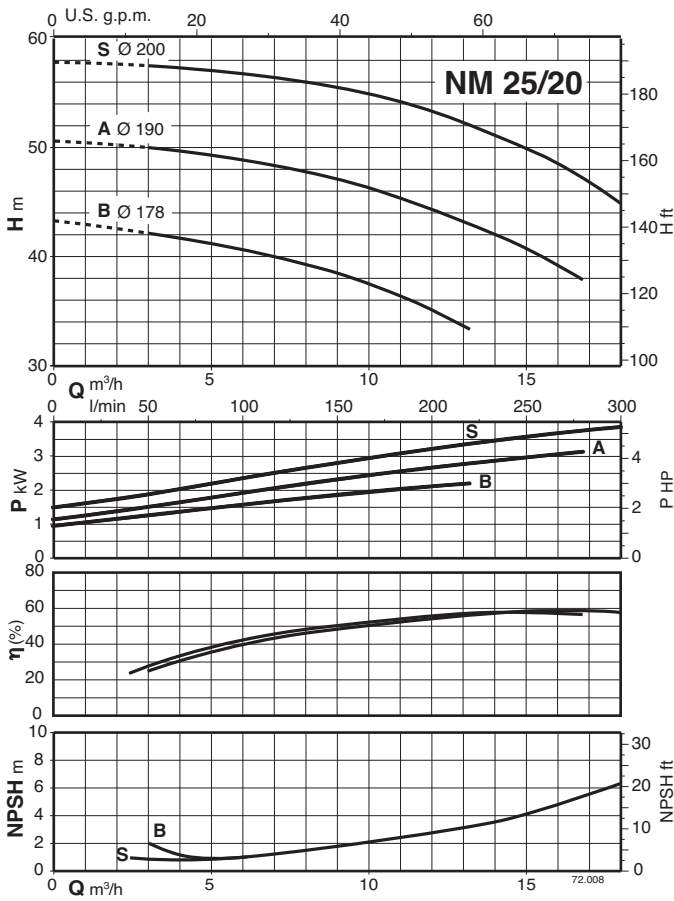

Characteristic curves $n \approx 2900$ rpm

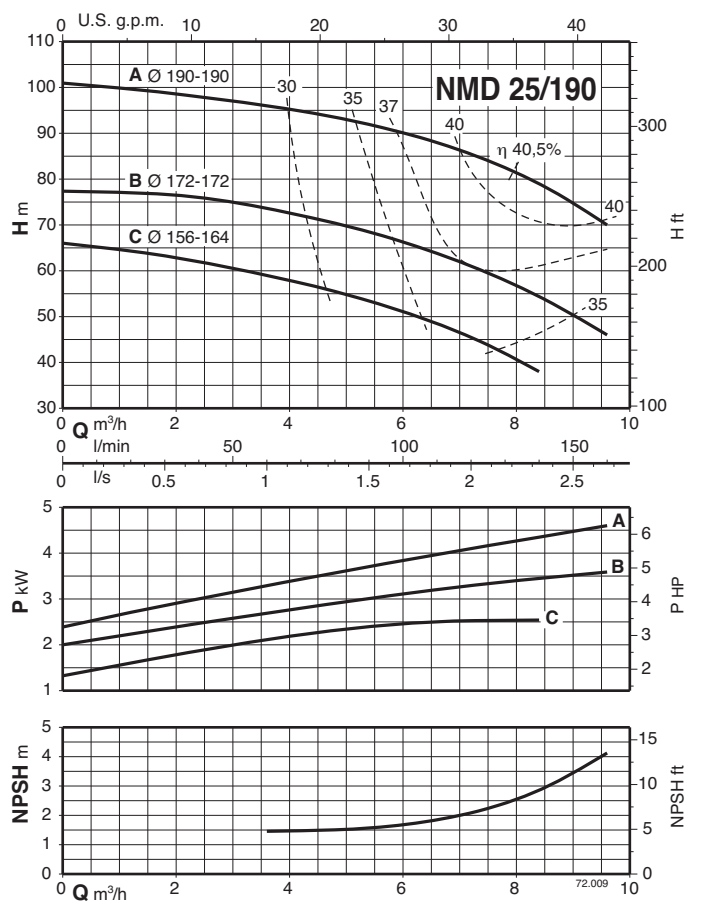
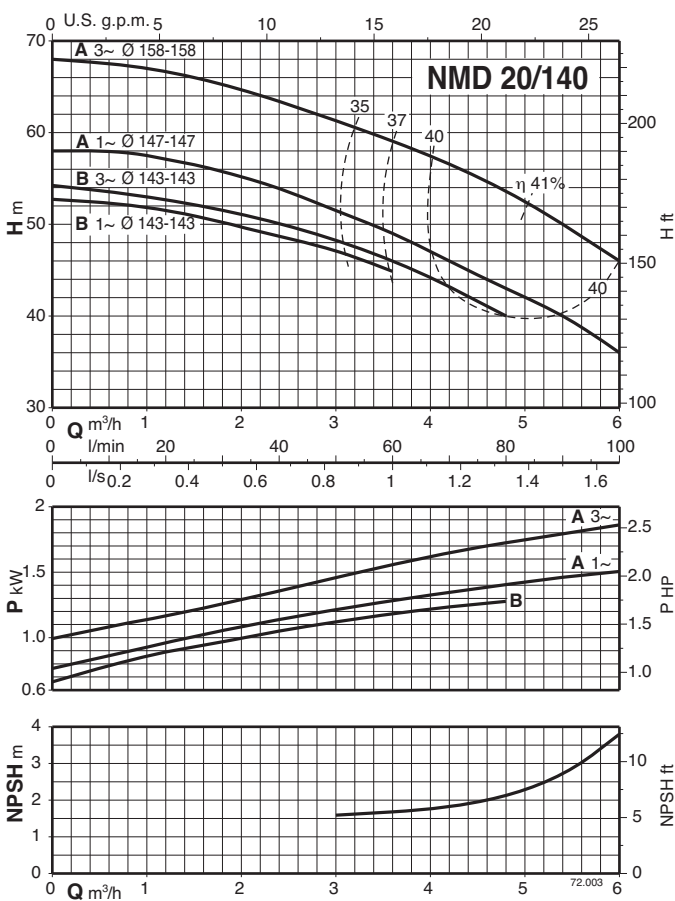
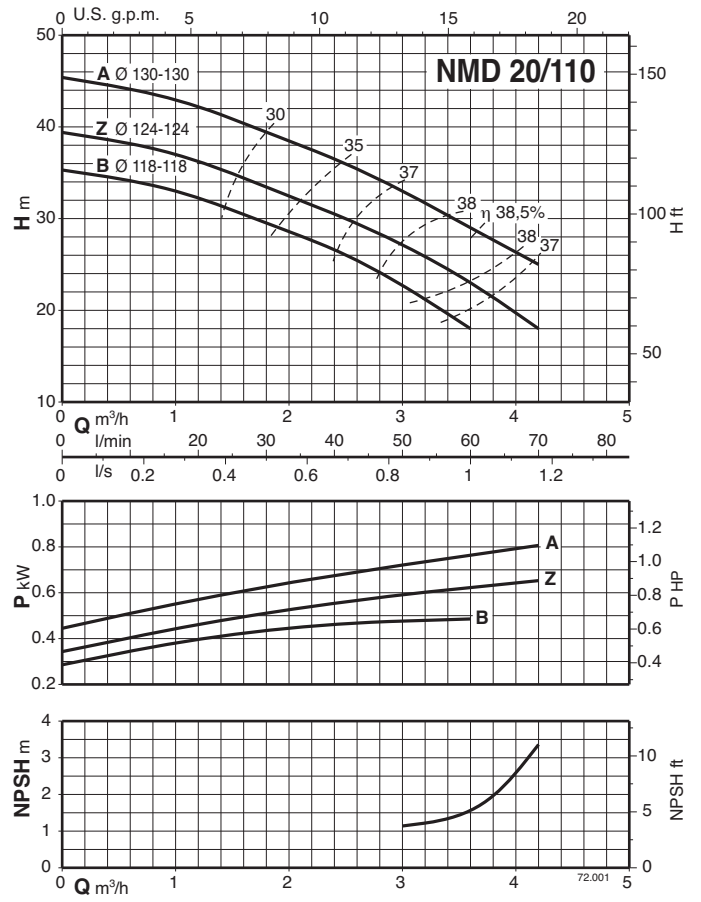
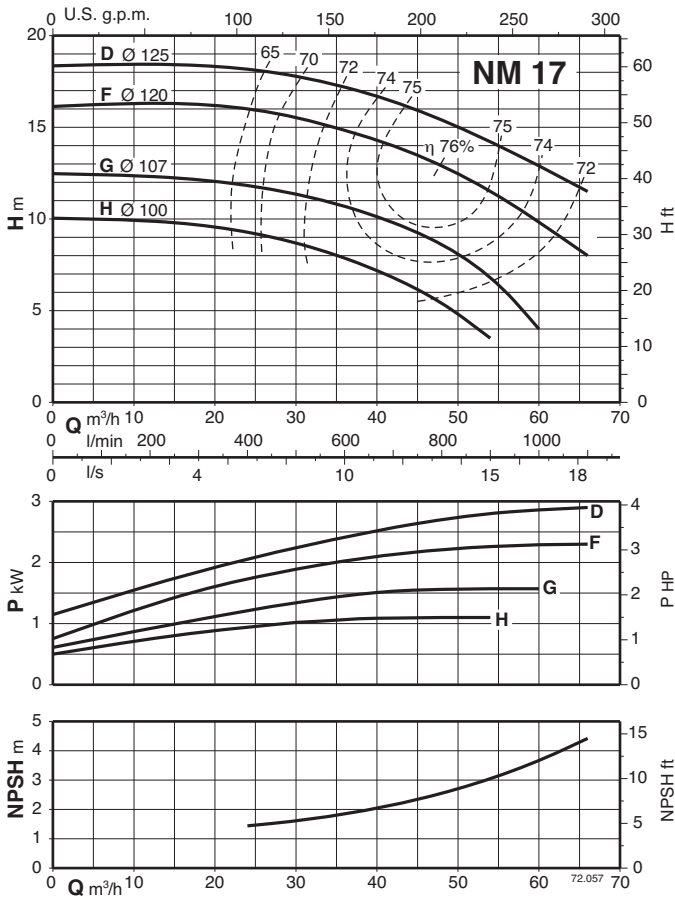

Characteristic curves $n \approx 2900$ rpm

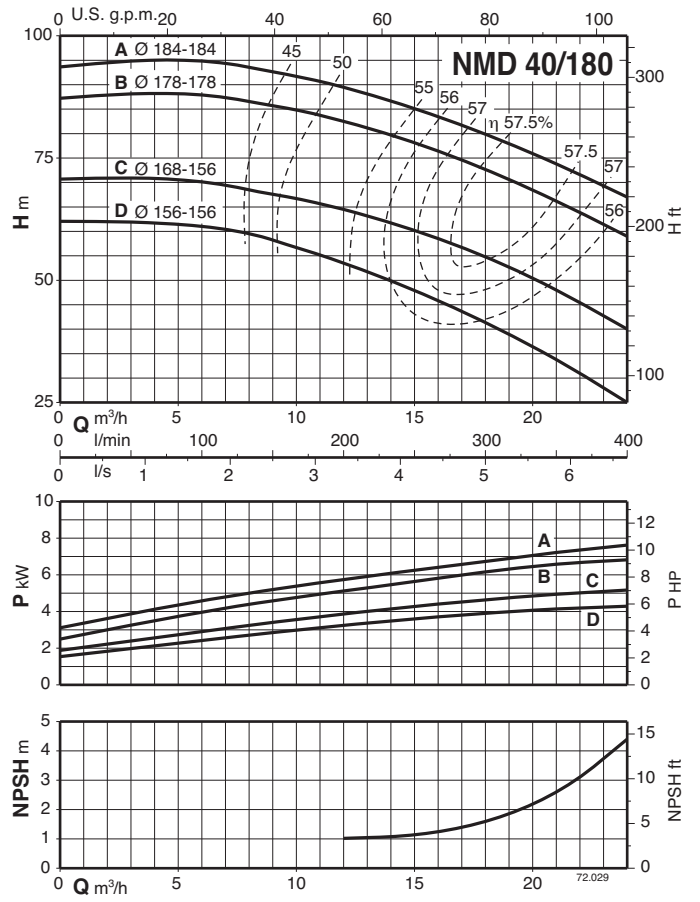
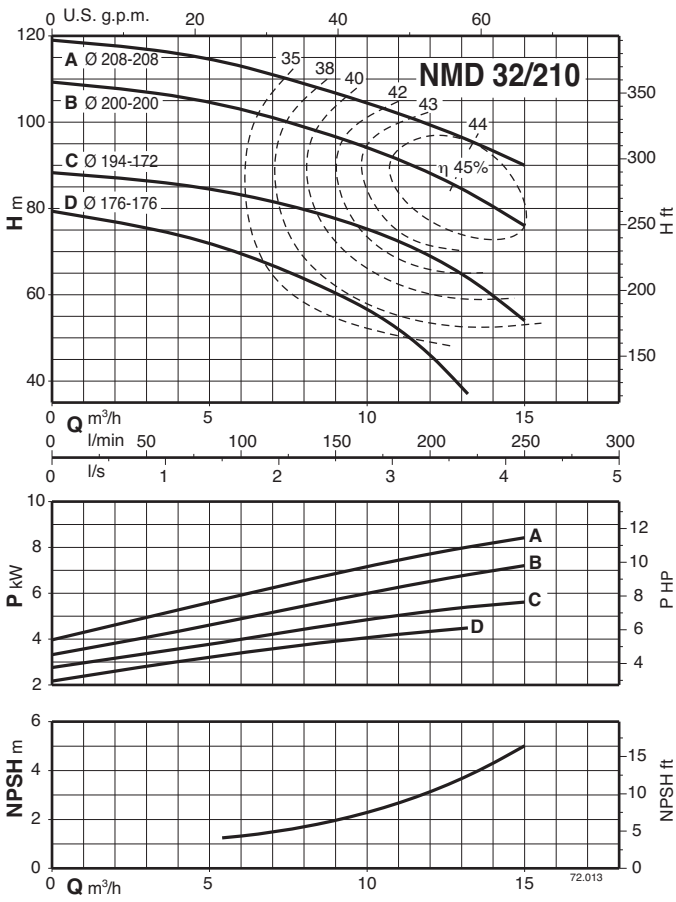

Dimensions and weights

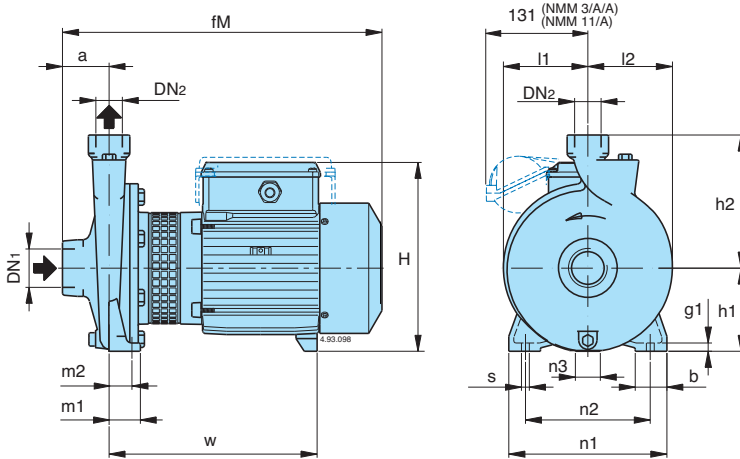

TYPE	NMM kg	NM kg	B-NM kg
NM 1/AE	8.5	8.5	
NM 2/B/A	13.8	12.7	
NM 2/S/A	14.4	13.2	
NM 2/A/B	15.1	15.1	
NM 6/B	17	17	
NM 6/A	19.2	19	
NM 3/C/A	23.1	23.3	
NM 3/B/A	25.2	25	
NM 3/A/B	28.6	28.2	
B- NM 20/160BE	19.3	18.4	20.1
B- NM 20/160A/A	20.8	20.8	22.2
B- NM 25/12B/A	13.4	12.5	13.7
B- NM 25/12A/B	14.6	14.6	15.7
B- NM 25/160B/A	21.1	20.7	22.6
B- NM 25/160A/A	23	22.5	24.2
NM 25/20B/C		29.6	
NM 25/20A/B		35.9	
NM 25/20S/C		40.6	
B- NM 25/200B/C			33.4
B- NM 25/200A/C			39.9
B- NM 25/200S/C			43.9
NM 10/FE	19.2	18.2	
NM 10/DE	19.3	18.3	
NM 10/A/A	20.5	20.7	
NM 10/S/A	22.2	21.9	
NM 11/B/A	25	24.9	
NM 11/A/B	28.5	28.8	
NM 12/D/B		31.5	
NM 12/C/A		39	
NM 12/A/B		42.6	
B- NM 17/H/A	22.3	22.8	25.5
B- NM 17/G/A	23.7	24.3	27
B- NM 17/F/B		27.7	30.4
B- NM 17/D/A		33.7	37.5

B-NM	NM	DN ₁ ISO 228	DN ₂	mm															
				a	fM	h ₁	h ₂	H	m ₁	m ₂	n ₁	n ₂	n ₃	b	s	l ₁	l ₂	w	g ₁
	NM 1/AE	G 1	G 1	40	261	80	132	176	40	32	170	140	17	35	9,5	77	81	171	10
	NM 2/A/B-S/A-B/A	G 1	G 1	45	305	95	150	207	40	32	190	160	17	35	9,5	87	90	203	10
	NM 6/A-B	G 1 1/4	G 1	53	349	100	150	213	37,5	27,5	190	150	17	38	9,5	102	102	235	10
	NM 3/B/A-C/A	G 1	G 1	50	375	112	180	240	55	43	245	205	37	45	11,5	110	113	244	12
	NM 3/A/B	G 1	G 1	50	415	112	180	240	55	43	245	205	37	45	11,5	110	113	284	12
	B- NM 20/160A/A-BE	G 1 1/4	G 3/4	53	375	100	150	228	37,5	27,5	190	150	30	38	9,5	102	102	246	10
	B- NM 25/12A/B-B/A	G 1 1/2	G 1	56	313	90	140	199	37,5	27,5	170	130	9	38	9,5	85	88	195	10
	B- NM 25/160A/A-B/A	G 1 1/2	G 1	56	380	100	160	228	37,5	27,5	190	150	30	38	9,5	102	102	246	10
	NM 25/20B/C	G 1 1/2	G 1	63	433	125	180	253	45	32,5	245	200	49	45	11,5	125	125	291	11
	NM 25/20A/B-S/C	G 1 1/2	G 1	63	460	125	180	263	45	32,5	245	200	42	45	11,5	125	125	295	11
	B- NM 25/200B/C	G 1 1/2	G 1	63	445	125	180	253	45	32,5	245	200	49	45	11,5	125	125	303	11
	B- NM 25/200A/B-S/C	G 1 1/2	G 1	63	460	125	180	263	45	32,5	245	200	42	45	11,5	125	125	295	11
	NM 10/S/A-A/A-DE-FE	G 2	G 1 1/4	63	382	100	150	228	50	35	190	140	30	50	13	90	97	239	14
	NM 11/B/A	G 2	G 1 1/4	70	400	112	170	240	50	35	210	160	37	50	15	103	110	247	14
	NM 11/A/B	G 2	G 1 1/4	70	440	112	170	240	50	35	210	160	37	50	15	103	110	287	14
	NM 12/D/B	G 2	G 1 1/4	70	440	132	190	260	50	35	240	190	47	50	15	125	127	287	14
	NM 12/A/B-C/A	G 2	G 1 1/4	70	470	132	190	270	50	35	240	190	45	50	15	125	127	300	14
	B- NM 17/G/A-H/A	G 2 1/2	G 2 1/2	80	417	112	160	240	50	35	210	160	37	50	14	96	113	257	14
	B- NM 17/F/B	G 2 1/2	G 2 1/2	80	463	112	160	240	50	35	210	160	37	50	14	96	113	304	14
	B- NM 17/D/A	G 2 1/2	G 2 1/2	80	480	112	160	250	50	35	210	160	20	50	14	96	113	295	14

Dimensions and weights

NMD 20/110

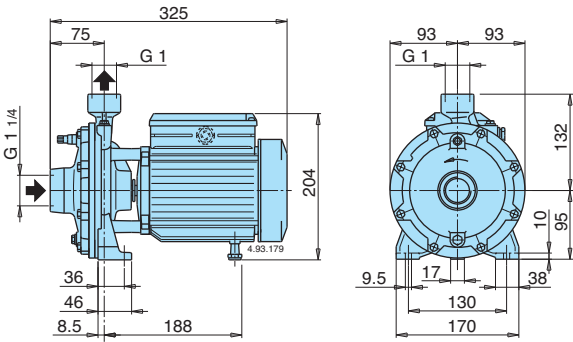

TYPE	NMDM kg	NMD kg	B-NMD kg
B- NMD 20/110B/A	13.2	12.2	13.6
B- NMD 20/110Z/A	14.4	13.4	14
B- NMD 20/110A/B	15.4	15.5	16.5

NMD 20/140 NMD 25/190

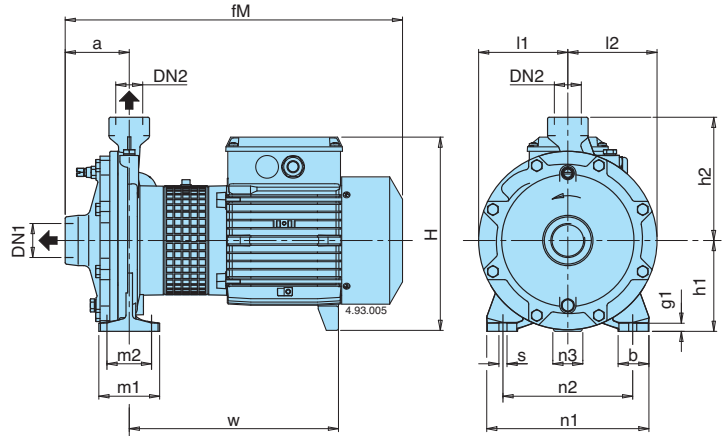

TYPE	NMDM kg	NMD kg	B-NMD kg
B- NMD 20/140B/A	23.6	24.3	27.2
B- NMD 20/140A/A	25.7	26	28.7
B- NMD 25/190C/B		41.9	45.7
B- NMD 25/190B/A		48.3	53.9
B- NMD 25/190A/B		52.4	56.2

B-NMD	NMD	DN1 ISO 228	DN2	mm																
				a	fM	h1	h2	H	m1	m2	n1	n2	n3	b	s	l1	l2	w	g1	
B- NMD 20/140A/A-B/A	NMD 20/140A/A-B/A	G 1 1/4	G 1	80	417	112	152	243	75	55	200	160	37	38	9,5	110	110	256	10	
B- NMD 25/190C/B	NMD 25/190C/B	G 1 1/2	G 1	97	487	140	180	268	100	70	240	190	50	49	50	14	133	133	314	13
B- NMD 25/190A/B-B/B	NMD 25/190A/B-B/A				500			278											306	

NMD 32/210 NMD 40/180

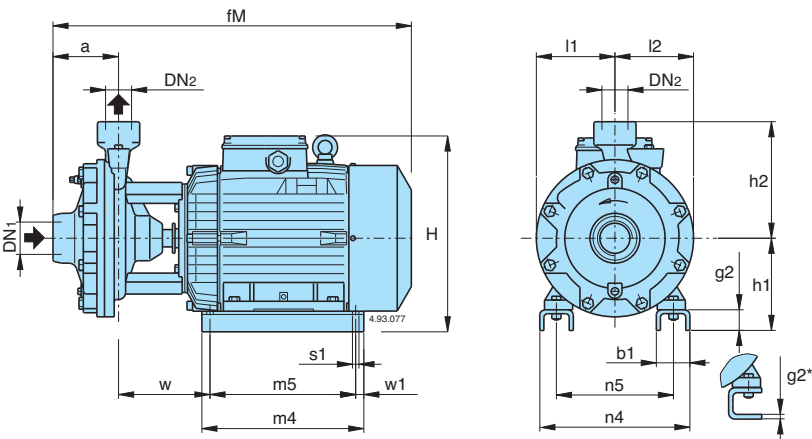

TYPE	NMD kg	B-NMD kg
B- NMD 32/210D/B	60.7	64.8
B- NMD 32/210C/A	71.7	76.8
B- NMD 32/210B/A	77.9	82.5
B- NMD 32/210A/B	97.5	103.6
B- NMD 40/180D/B	59.3	66.8
B- NMD 40/180C/A	69.7	76
B- NMD 40/180B/A	75.1	81.5
B- NMD 40/180A/B	97.7	101.2

B-NMD	NMD	DN1 ISO 228	DN2	mm															
				a	fM	h1	h2	H	m4	m5	n4	n5	w1	b1	s1	l1	l2	w	g2
B- NMD 32/210D/B	NMD 32/210D/B	G 2	G 1 1/4	110	530	155	215	293	205	175	194	140	15	54	10	150	150	139	6*
B- NMD 32/210B/A -C/A	NMD 32/210B/A -C/A				550	150	215	310	280	250	258	190	15	68	12	150	150	108	38
B- NMD 32/210A/B	NMD 32/210A/B				625	170		355	298	268	286	216		70	12			152	38
B- NMD 40/180D/B	NMD 40/180D/B				535	155		293	205	175	194	140		54	10			133	6*
B- NMD 40/180B/A -C/A	NMD 40/180B/A -C/A	G 2	G 1 1/2	121	555	150	215	310	280	250	258	190	15	68	12	145	145	102	38
B- NMD 40/180A/B	NMD 40/180A/B				630	170		355	298	268	286	216		70	12			145	38

Features

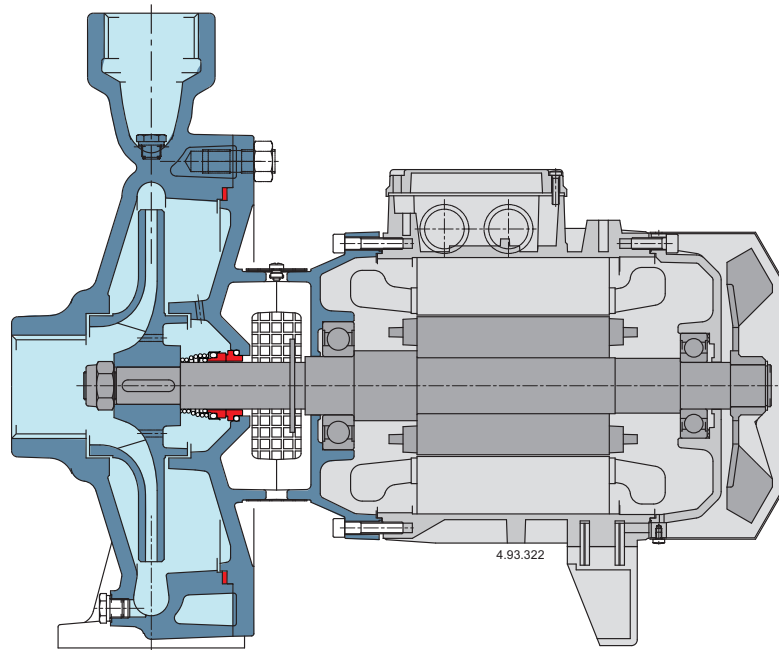

Compact Design

The compact design allows for easy installation even in confined spaces.

Robust

The mechanical structure of the hydraulic parts in contact with the pumped liquid are dimensioned to guarantee the maximum resistance to mechanical stress.

A unique design

The lantern bracket design prevents contact with the pumps rotating parts, providing protection to the end user whilst allowing for inspection of the mechanical seal.

Reliable

The bearing and shaft are designed to ensure the reduction of the stress, providing high reliability under all operating conditions.

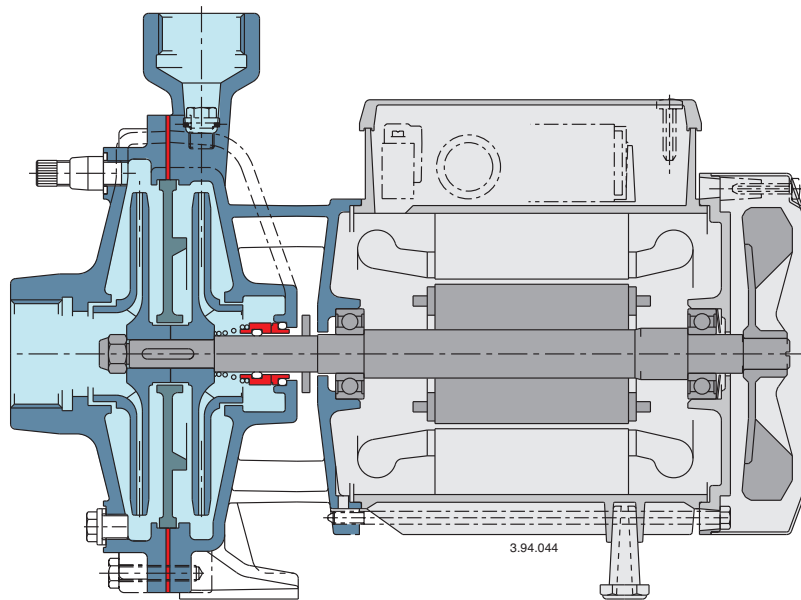
Features**Flexible**

The option to choose between cast iron and bronze materials for the hydraulic parts in contact with the pumped liquid allows NMD series pumps to be selected for use with different types of liquids.

Robust

The mechanical structure of the hydraulic parts in contact with the pumped liquid are dimensioned to guarantee the maximum resistance to mechanical stress.

Reliable

The bearing and shaft are designed to ensure the reduction of the stress, providing high reliability under all operating conditions.