

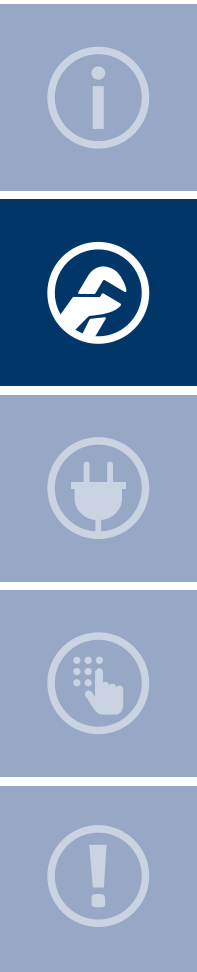

SCALA2





1



144 mm / 5.6 inch

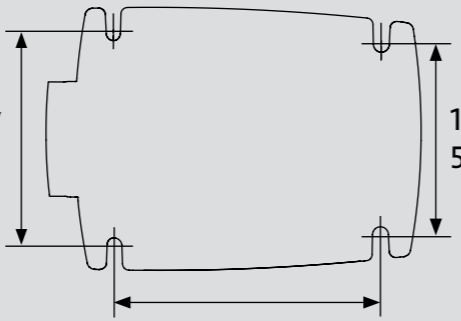

130 mm / 5.1 inch

181 mm / 7.1 inch

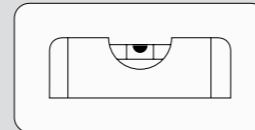
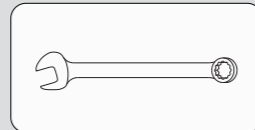

× 4

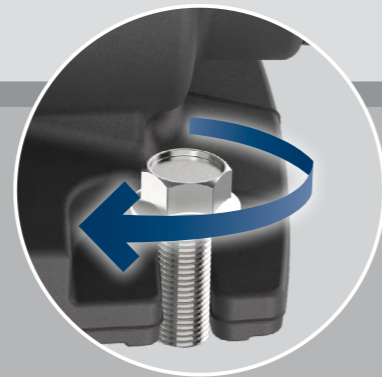

2



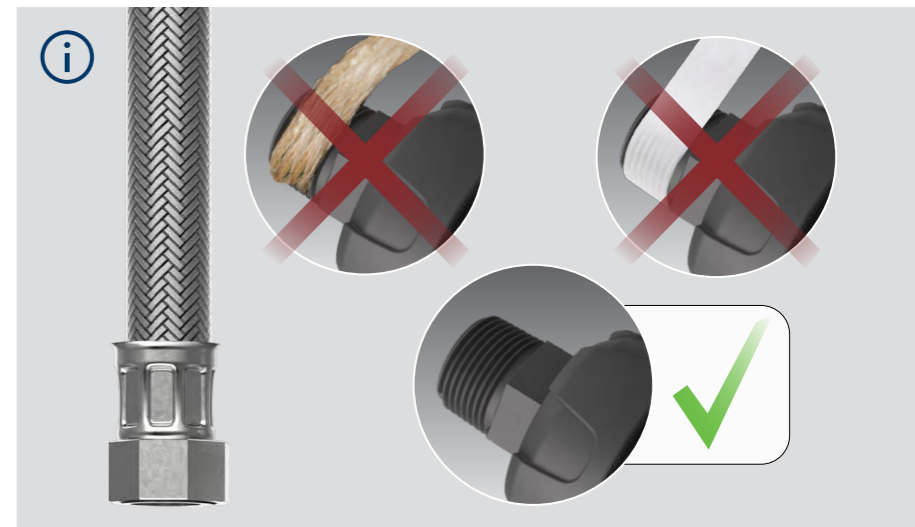
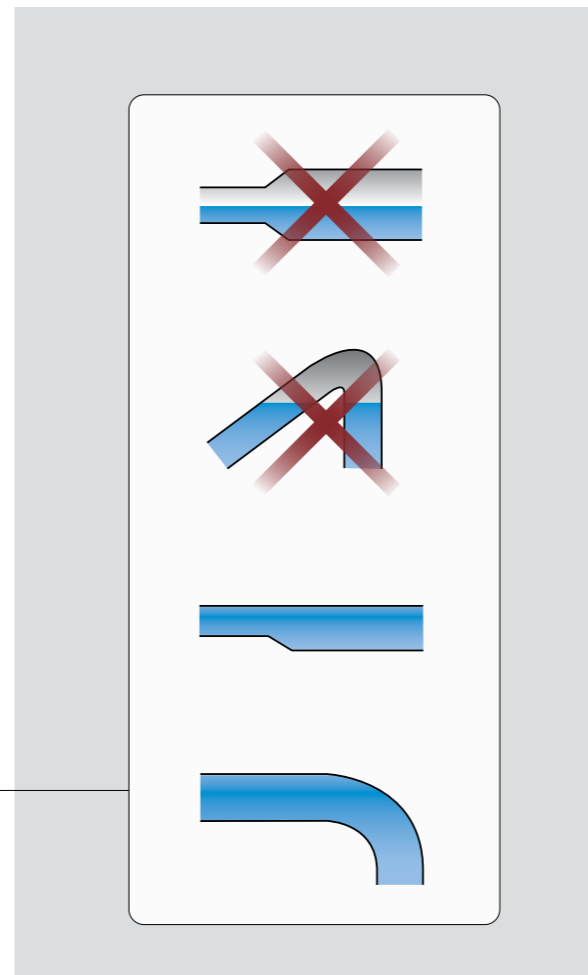
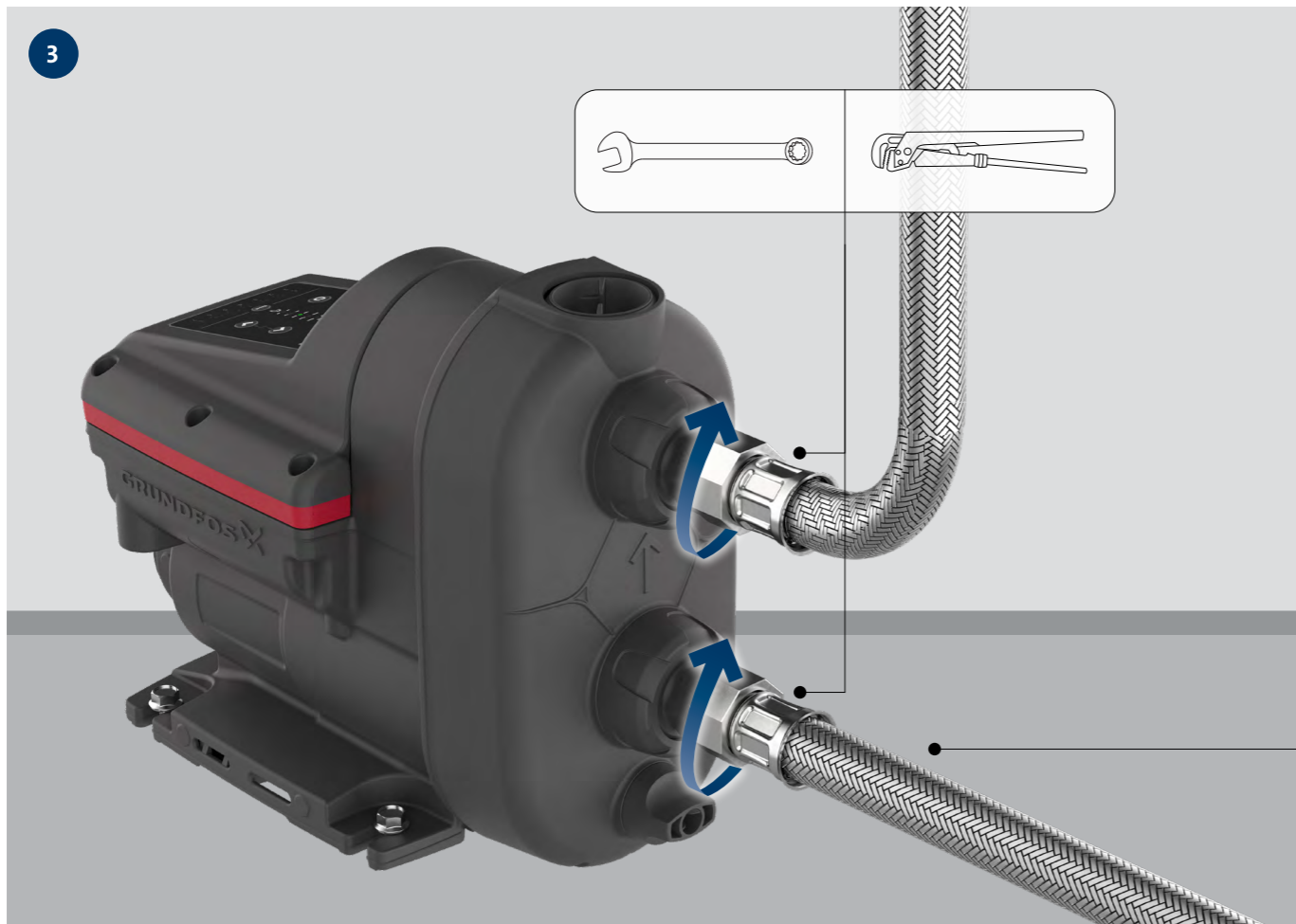
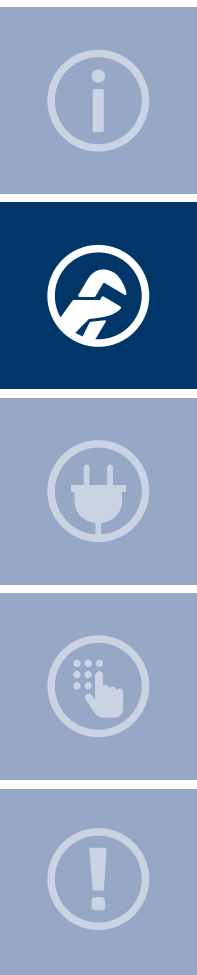

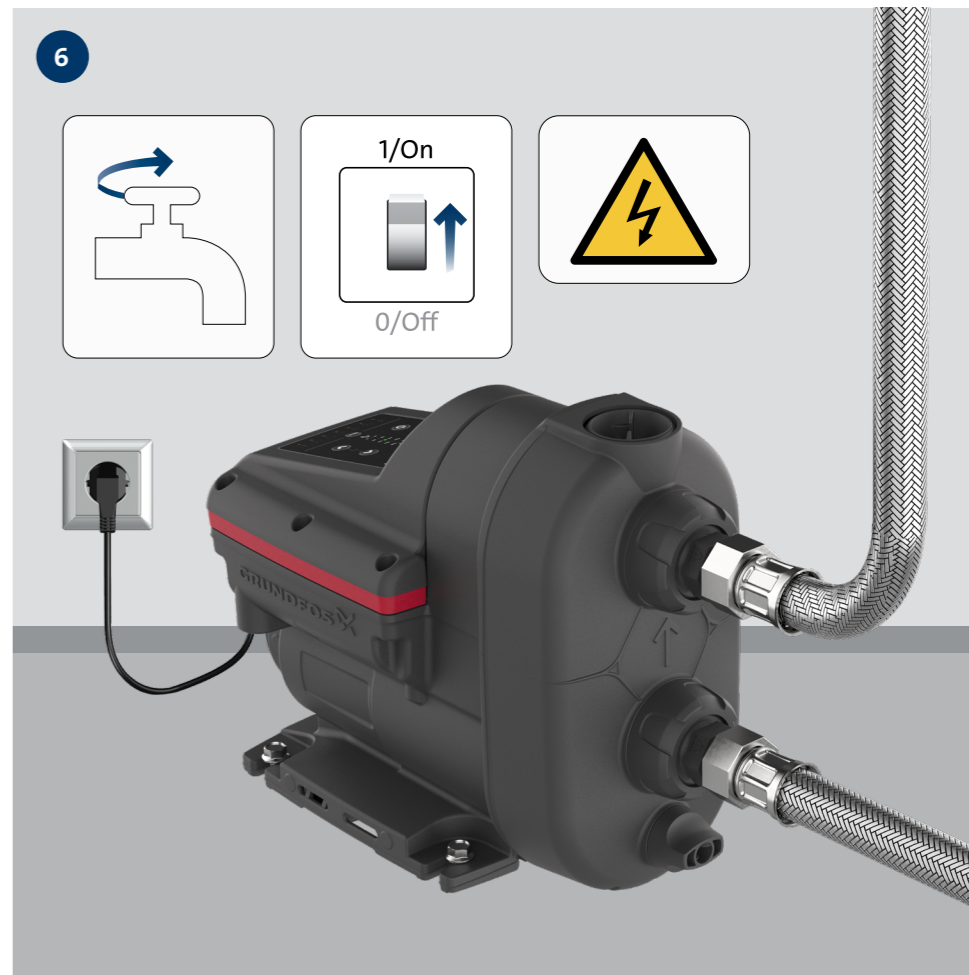
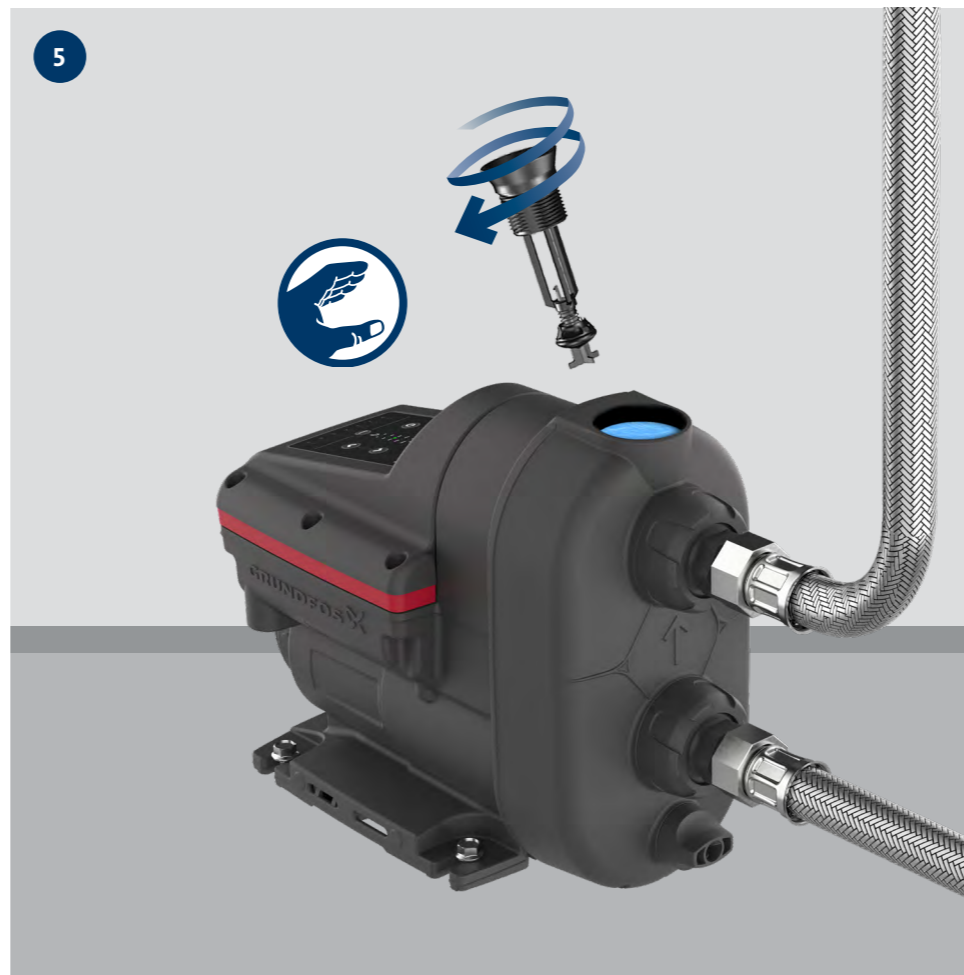
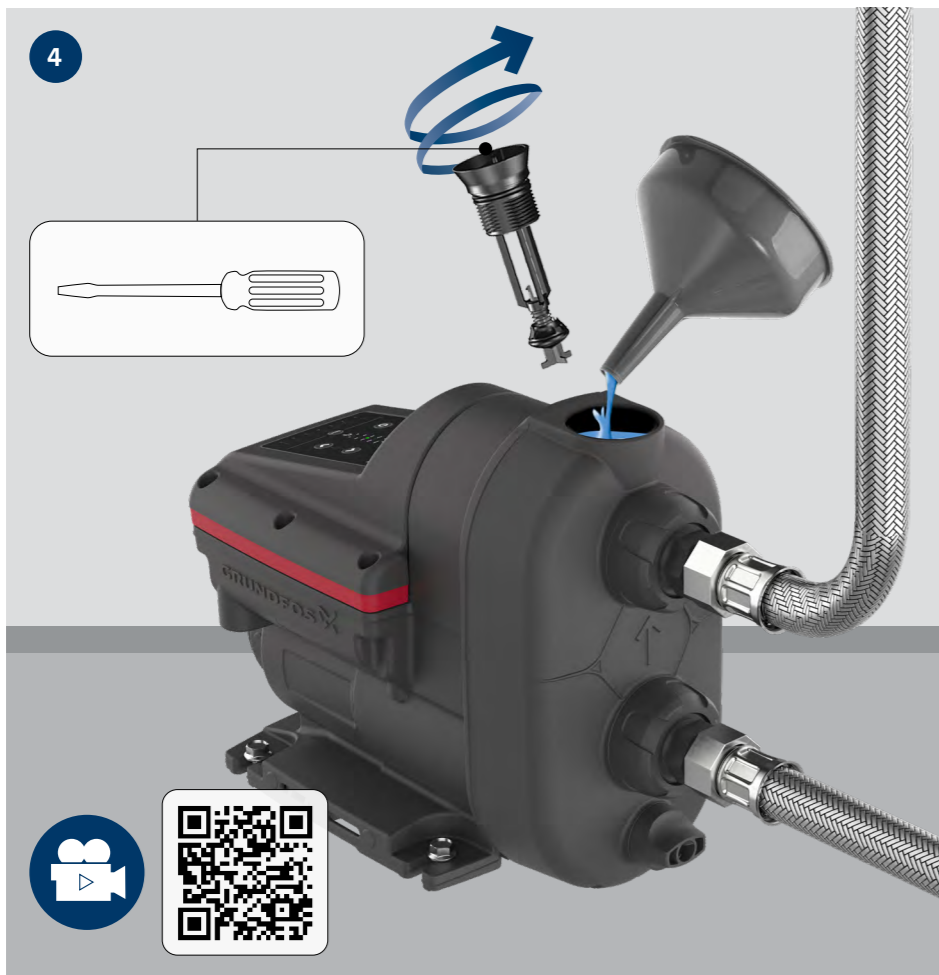
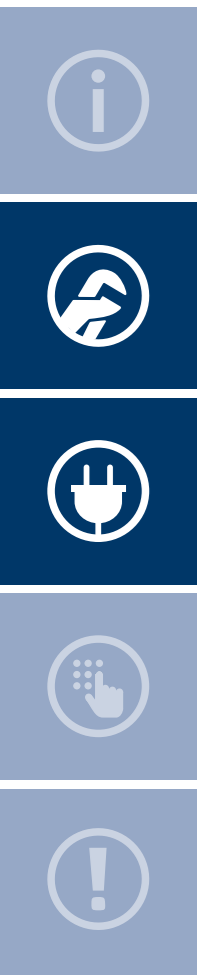

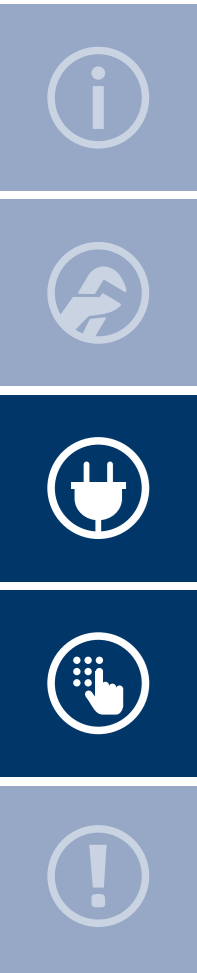

7

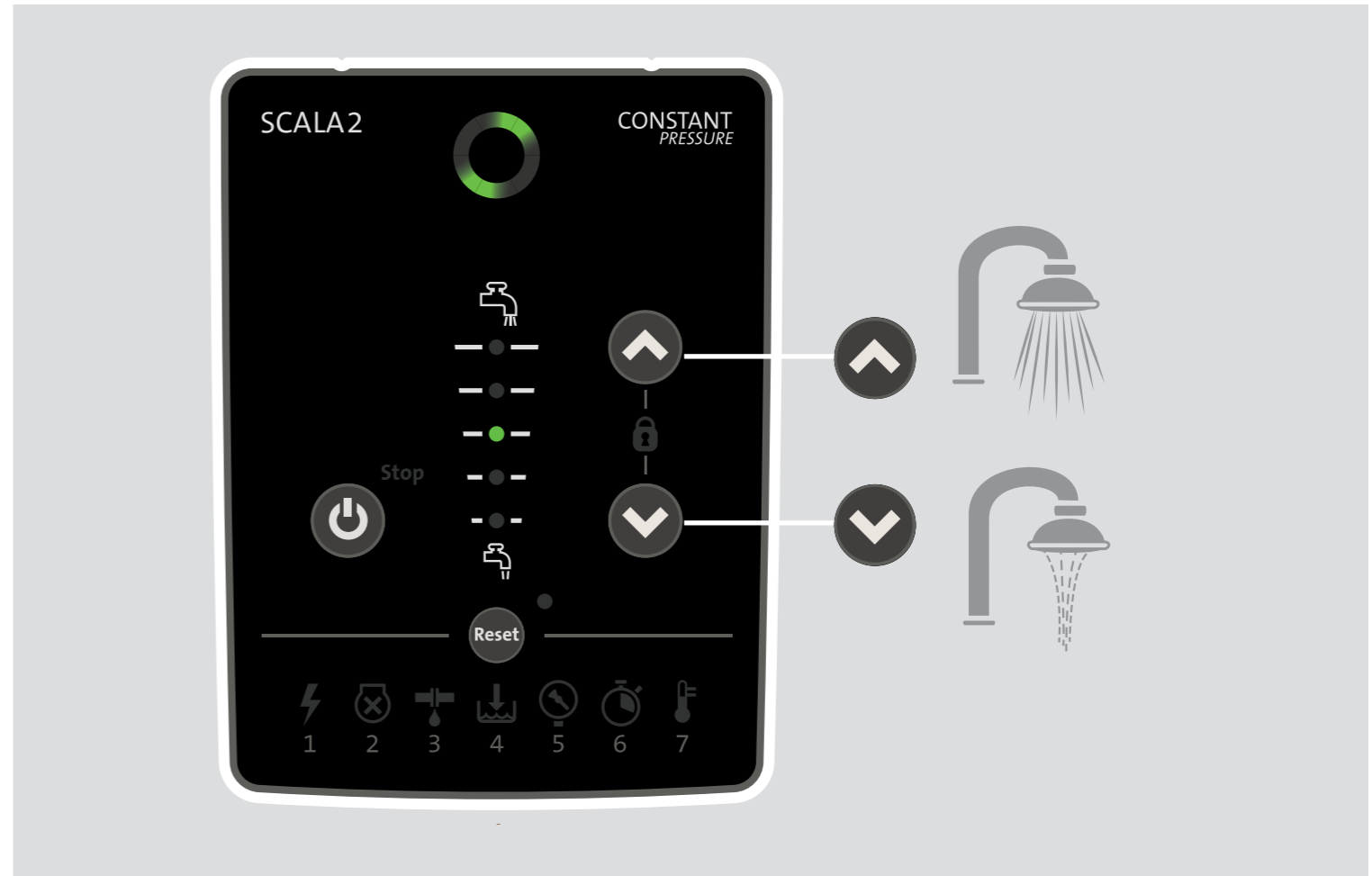
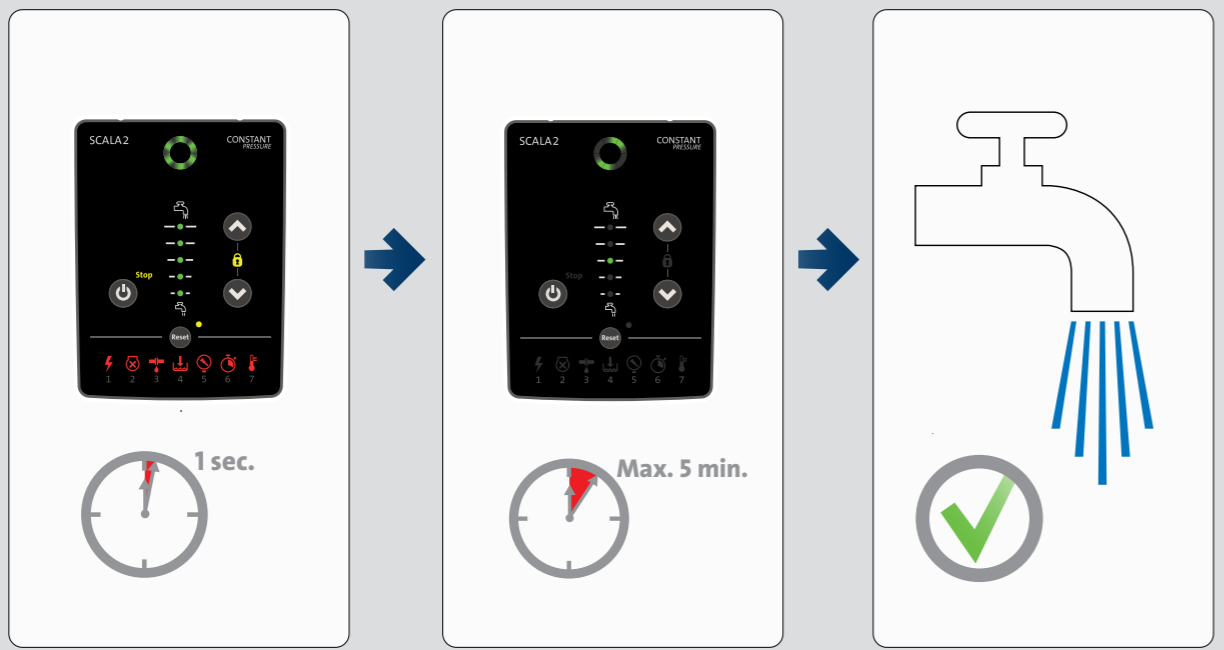

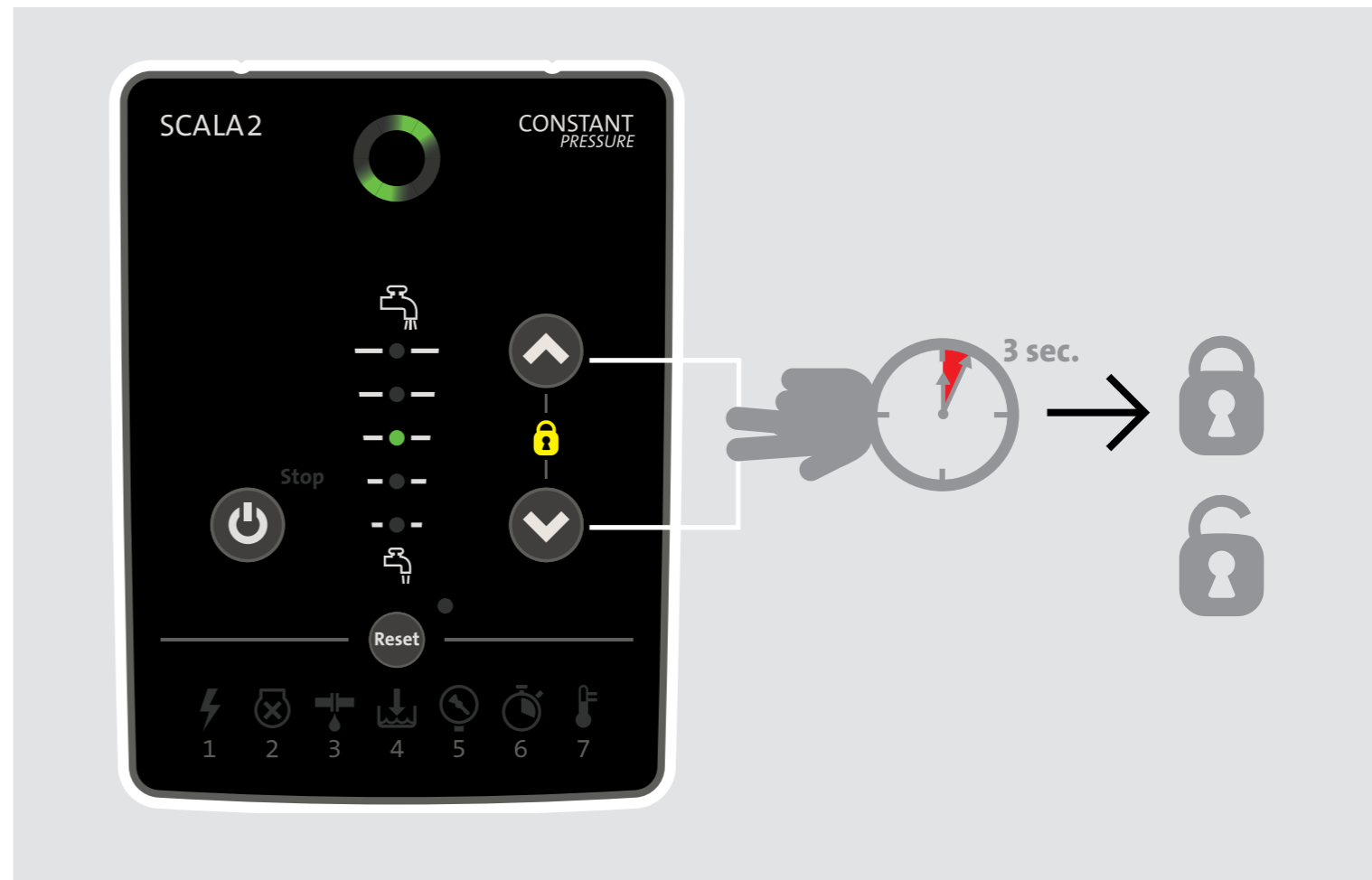
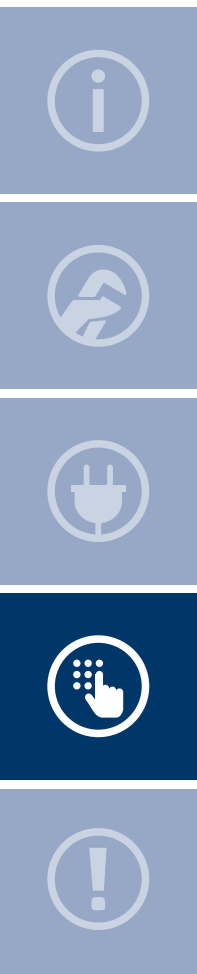

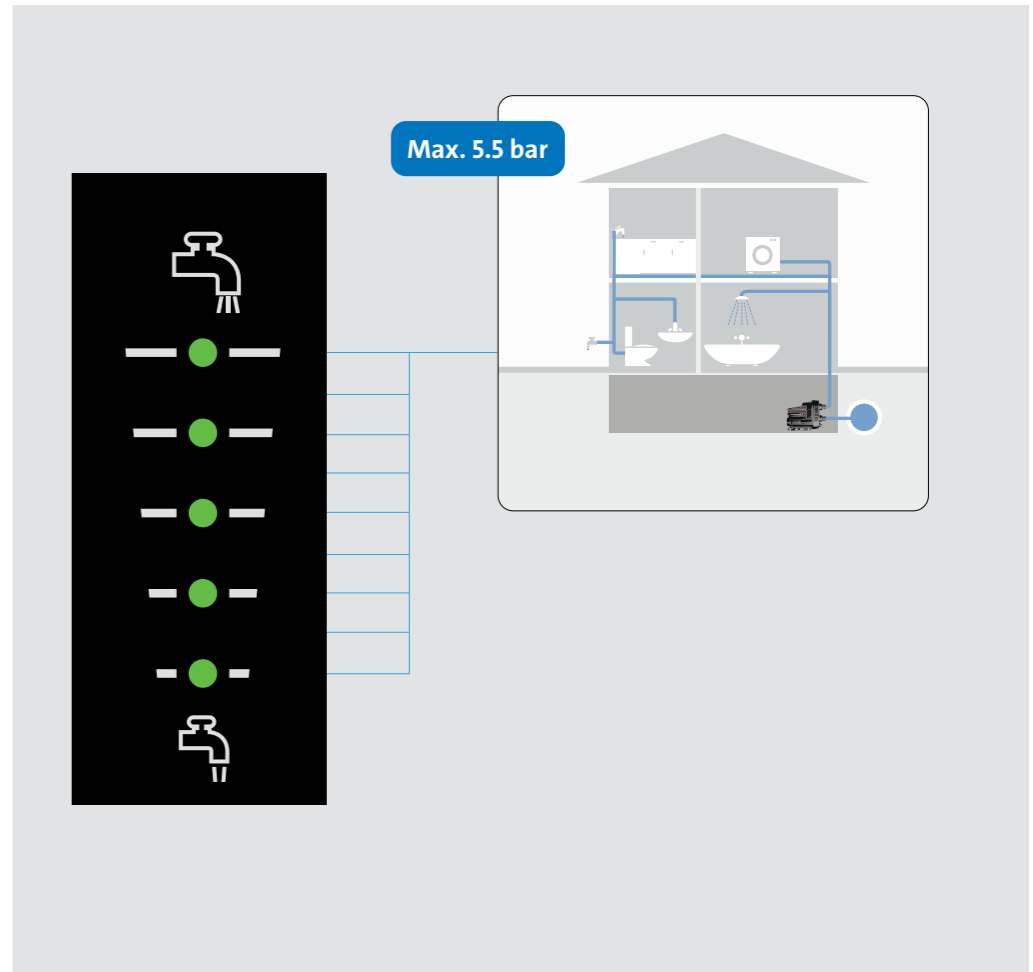
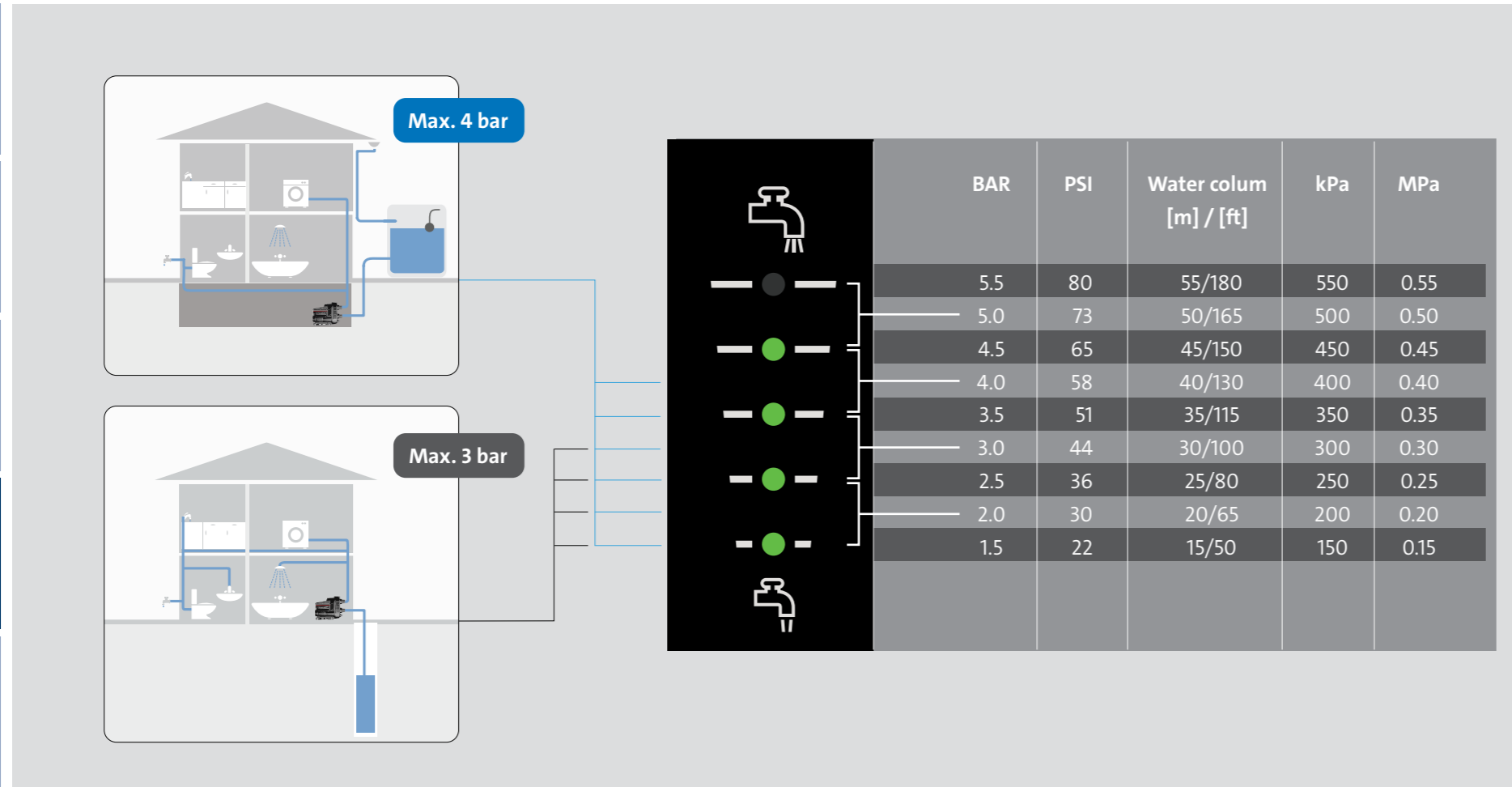
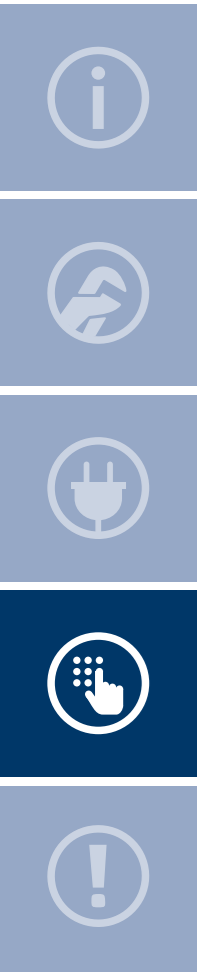

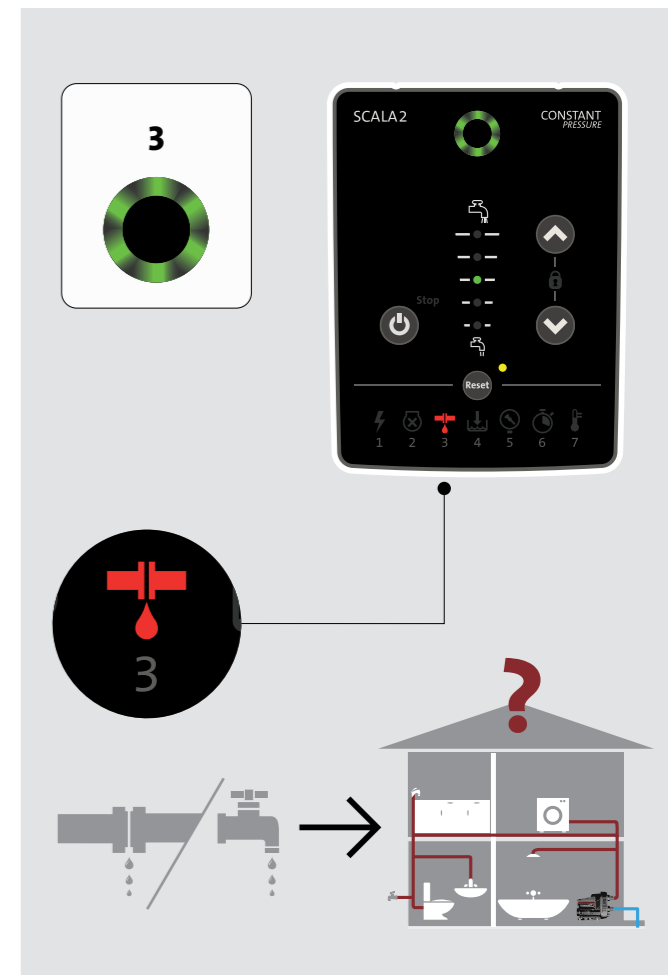
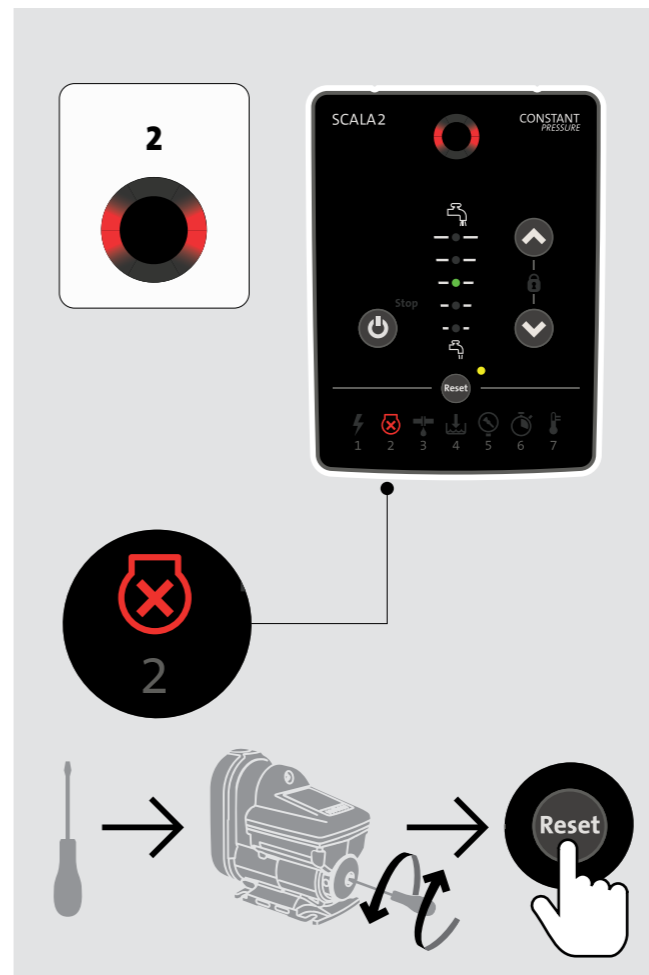
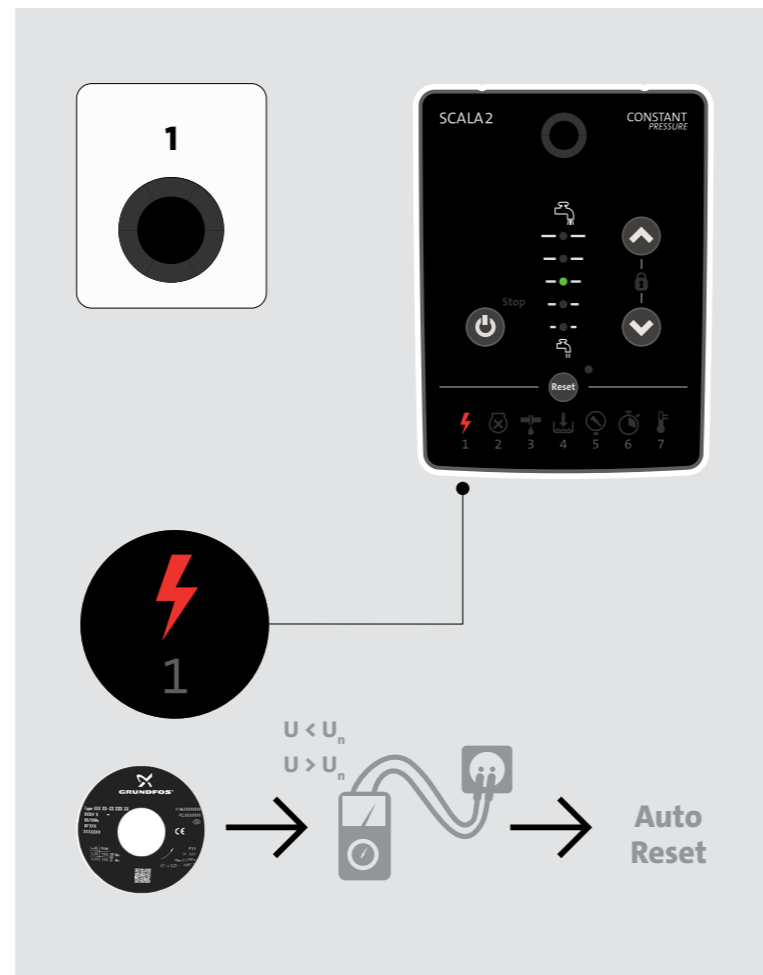
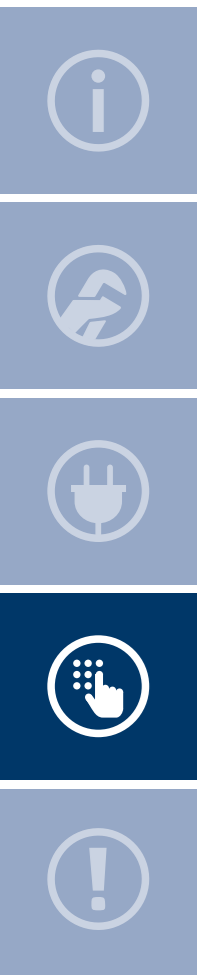

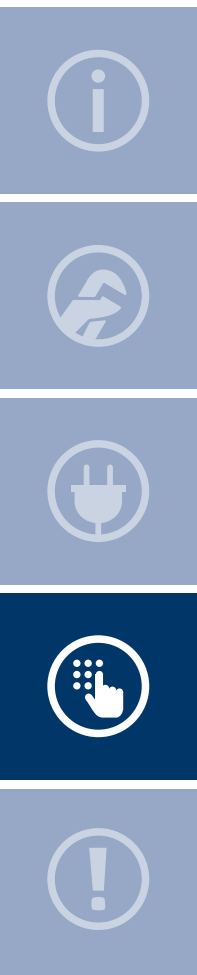

4

SCALA2 CONSTANT PRESSURE

4

5

SCALA2 CONSTANT PRESSURE

5

6

SCALA2 CONSTANT PRESSURE

6

7

SCALA2 CONSTANT PRESSURE

7



93058721

ECM: 1380601 | 11.2023

GRUNDFOS Holding A/S
Poul Due Jensens Vej 7
DK-8850 Bjerringbro
Tel: +45 87 50 14 00
www.grundfos.com

GRUNDFOS